

konusulan
the spoken kalite...
quality...



2022
ÜRÜN BROŞÜRÜ
PRODUCT BROCHURE

www.akkocom.tr





1986 yılında Abdullah KARAKUŞ tarafından kurulan AKKO Oto. Mak. Hırd. San. Tic. Ltd. Şti. Tornalama Takımları, Diş ve Kanal Açma Takımları, Delik Delme Takımları, Frezeleme Takımları ve Özel Takımları üretmektedir. Şu an 36,500 m² ye yakın bir alanda Türkiye, Japonya, Almanya, İsviçre gibi ülkelerin ürettikleri son teknoloji tezgah ve ekipmanlarıyla yıllık 400.000 adet üretim kapasitesiyle, standart 8000 çeşit takım üretimi yapmaktadır. Avrupa, Asya, Afrika, Güney Amerika, Kuzey Amerika ve Orta Doğu'da şimdilik 85 ülkeye ürün sevkiyatına devam etmekte olup 300.000 adet civarında üretilmiş ürün stoklarında mevcuttur. Firmaya, özel üretilen çelik hammadde işleme girer ve bütün üretim süreci bünyesinde gerçekleşir. Çeliğin işlenmesi, ısıtma işlemi, üzerindeki kaplama ve her türlü üretim süreci bir entegre tesis olan AKKO'da gerçekleşir.



We as AKKO Oto. Mak. Hird. San. Tic. Ltd. Şti, which has been founded by Abdullah KARAKUŞ in 1986, produce Turning Tool Holders, Threading and Grooving Tool Holders, U-Drills, Milling Tool Holders and Precision Tool Holders (OEM Tool Holders). We produce standard 8000 kinds of tool holders with production capacity of 400.000 pieces per annum in an area about 36,500 square meter. We are going on exporting 85 countries including European, Asian, African, Asian, South American Countries, North American Countries and Middle East Countries. We keep ready about 300.000 pieces produced products in our stock. Steel Raw materials that we make produced especially for us are delivered our factory and all production process are made in our factory. All kind of process from machining of steel to heat treatment and coating on our tools are made in our integrated factory AKKO.

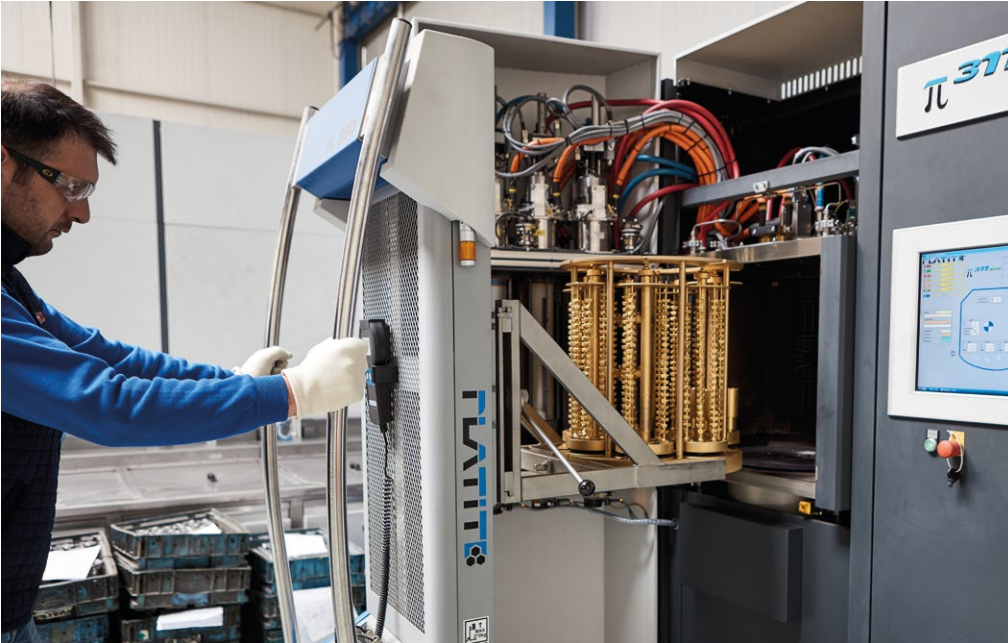



KALİTE KONTROLÜMÜZ ALTINDA





Yüksek teknolojiye sahip makinelerimizde üretilen ürünlerimiz ile önceliğimiz müşteri memnuniyetini sağlamaktır. Bu kapsamda mevcut laboratuvarımızda bulunan hassas ölçüm ve malzeme test cihazları ile uzman kadromuz tüm kalite kontrol proseslerini gerçekleştirmektedir. Hammaddede giriş kontrolünden itibaren imalat proses sürecinde ara kontroller, imalat sonrası son kontroller ve sürekli iyileştirme çalışmaları yapılarak yüksek kalitede ürünler üretilmektedir. Firmamızın temel amacı en kaliteli ürünü, en ekonomik şekilde ve tam zamanında üretmektir.

UNDER OUR QUALITY CONTROL

Our priority is to provide customer satisfaction with our products produced in our high-tech machines. In this context, our expert staffs carries out all quality control processes with precision measurement and material testing devices in our current laboratory. High quality products are produced from the raw material with entry control through the use of intermediate controls, post-production final checks and continuous improvement studies in the manufacturing process. The main purpose of our company is to produce the highest quality products in the most economical way and on time.

Kesici Uçlar ve Takımları / Cutting Inserts and Toolholders

POLY-V Kanal Açma Uçları ve Takımları / POLY-V Grooving Inserts and Toolholders

| | | | |
|--|--|--|---|
|  <p>AKKO (T12P) UCUNA UYGUNDUR COMPATIBLE WITH AKKO (T12P) INSERT</p> | <p>ADKT-T12P-R/L-1616-T5 ADKT-T12P-R/L-2020-T5 ADKT-T12P-R/L-2525-T5 ADKT-T12P-R/L-3232-T5</p> |  | <p>T12.10.0234.PJ.R T12.10.0356.PK.R T12.10.0470.PL.R</p> |
|  <p>AKKO (T12P) UCUNA UYGUNDUR COMPATIBLE WITH AKKO (T12P) INSERT</p> | <p>ATPVK 2020 K2.34X4 ATPVK 2525 M2.34X4 ATPVK 3232 P2.34X4 ATPVK 2020 K3.56X4 ATPVK 2525 M3.56X4 ATPVK 3232 P3.56X4 ATPVK 2020 K4.7X3 ATPVK 2525 M4.7X3 ATPVK 3232 P4.7X3</p> |  | <p>B26.07.0234.PJx4 B26.07.0356.PKx4 B26.07.0470.PLx3</p> |

Kanal Açma, Köşe Boşaltma Uçları ve Takımları / Inserts and Toolholders For Grooving Corner Reliefs

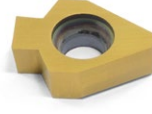
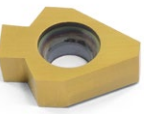
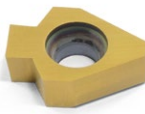
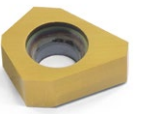

| | | | |
|--|---|---|---|
|  <p>AKKO (T20) UCUNA UYGUNDUR COMPATIBLE WITH AKKO (T20) INSERT</p> | <p>AAUT-T20-R/L-1616-45 AAUT-T20-R/L-2020-45 AAUT-T20-R/L-2525-45</p> |  <p>T20.00.0815.45.04R/L T20.00.1220.45.05R/L T20.00.2024.45.06R/L</p> |  <p>T20.00.1220.45.20R/L</p> |
|--|---|---|---|

Broş Çekme Uçları ve Takımları / Broaching Inserts and Toolholders

| | | | | |
|---|---|---|--|---|
|  <p>AKKO (B41-B42) UCUNA UYGUNDUR COMPATIBLE WITH AKKO (B41-B42) INSERT</p> | <p>ABT-B41-D17-Y25-L90-I040 ABT-B41-D17-Y25-L105-I065 ABT-B41-D22-Y25-L100-I050 ABT-B41-D22-Y25-L125-I070 ABT-B42-D30-Y32-L100-I050 ABT-B42-D30-Y32-L125-I075</p> | <p>ABT-B42-D30-Y32-L170-I110 ABT-B42-D38-Y32-L100-I050 ABT-B42-D38-Y32-L125-I075 ABT-B42-D40-Y32-L100-I050 ABT-B42-D40-Y32-L125-I075</p> |  <p>DIN6885 (Tolerans C11) torna ve freze tezgahlarında broş çekme uçları. DIN6885 (Tolerance C11) inserts for keyway broaching on lathe and milling machines.</p> | <p>B41.00.0612.085.VP3001 B41.00.0713.085.VP3001 B41.00.0813.105.VP3001 B42.00.1013.105.VP3001 B42.00.1215.135.VP3001 B42.00.1215.175.VP3001 B42.00.1215.225.VP3001</p> |
|  <p>DIN6885 (Tolerans P9) torna ve freze tezgahlarında broş çekme uçları. DIN6885 (Tolerance P9) inserts for keyway broaching on lathe and milling machines.</p> | <p>B41.00.0498.020.VP3001 B41.00.0598.020.VP3001 B41.00.0798.020.VP3001 B42.00.0998.030.VP3001 B42.00.1197.030.VP3001 B42.00.1397.030.VP3001</p> |  <p>DIN6885 (Tolerans JS9) torna ve freze tezgahlarında broş çekme uçları. DIN6885 (Tolerance JS9) inserts for keyway broaching on lathe and milling machines.</p> | <p>B41.00.0501.020.VP3001 B41.00.0601.020.VP3001 B41.00.0801.020.VP3001 B42.00.1001.030.VP3001 B42.00.1200.050.VP3001 B42.00.1201.030.VP3001 B42.00.1401.030.VP3001</p> |  <p>Torna ve freze tezgahlarında kama kanalı pah kırma uçları. Inserts for keyway chamfering on lathe and milling machines.</p> <p>B41.00.0150.CH.VP3001 B41.00.0300.CH.VP3001 B42.00.0600.CH.VP3001</p> |

Supap Yuvası İşleme Uçları ve Takımları / Valve Seat Inserts and Toolholders

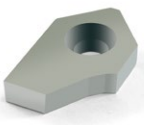
| | | | | | |
|--|--------------------------------------|--|---------------------|--|---------------------|
|  <p>AKKO (B11) UCUNA UYGUNDUR COMPATIBLE WITH AKKO (B11) INSERT</p> | <p>VST-B11-2842 VST-B11-4058</p> |  <p>AKKO (B11) UCUNA UYGUNDUR COMPATIBLE WITH AKKO (B11) INSERT</p> | <p>VST-B11-1830</p> |  <p>AKKO (B11) UCUNA UYGUNDUR COMPATIBLE WITH AKKO (B11) INSERT</p> | <p>VST-B11-2032</p> |
|--|--------------------------------------|--|---------------------|--|---------------------|

| | | | | | | | | |
|---|---|---|---|---|--------------------------|--------------------------|--------------------------|---------------|
|  | <p>B11003 B11004 B11005 B11006 B11007</p> | <p>B11008 B11009 B11010 B11011 B11012</p> | <p>B11014 B11016 B11017 B11018 B11019</p> |  | <p>B11015 B11023</p> | <p>B11024 B11025</p> | <p>B11026 B11027</p> | <p>B11028</p> |
|---|---|---|---|---|--------------------------|--------------------------|--------------------------|---------------|

| | |
|---|---|
|  <p>B11013</p> |  |
|---|---|

Whirling Uçları ve Takımları / Whirling Inserts and Toolholders

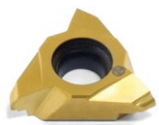
| | | | | | |
|--|--|--|--|--|--|
|  <p>AKKO (T09) UCUNA UYGUNDUR COMPATIBLE WITH AKKO (T09) INSERT</p> | <p>ATW-301-T09-D1240-Z06 ATW-302-T09-D1233-Z06 ATW-303-T09-D0620-Z06 ATW-304-T09-D1240-Z06 ATW-305-T09-D1245-Z06</p> | <p>ATW-306-T09-D1240-Z06 ATW-307-T09-D1250-Z06 ATW-308-T09-D1142-Z06 ATW-309-T09-D2054-Z08 ATW-310-T09-D1252-Z06</p> | <p>ATW-311-T09-D1252-Z06 ATW-312-T09-D1252-Z06 ATW-313-T09-D1650-Z06 ATW-314-T09-D2052-Z06 ATW-316-T09-D1252-Z06 ATW-315-T09-D1245-Z06</p> |  <p>Standart ISO 5835</p> | <p>T09.HA150.D12 T09.HA200.D12 T09.HA270.D12 T09.HA350.D12 T09.HA400.D12 T09.HA450.D12 T09.HA500.D12 T09.HB400.D12 T09.HB650.D12</p> |
|--|--|--|--|--|--|

| | | | | | |
|--|--|--|--|--|--|
|  <p>Standart ISO 5835</p> | <p>T09.HA150.D12 T09.HA200.D12 T09.HA270.D12 T09.HA350.D12 T09.HA400.D12 T09.HA450.D12 T09.HA500.D12 T09.HB400.D12 T09.HB650.D12</p> |  <p>Standart ISO 9268</p> | <p>T09.HC290.D12 T09.HC350.D12 T09.HC390.D12 T09.HC420.D12</p> |  <p>Standart ISO 9268</p> | <p>T09.HD400.D12 T09.HD450.D12</p> |
|--|--|--|--|--|--|

Dış Çap Tornalama Katerleri / External Turning Toolholders

| | | | | | |
|--|--|---|--|--|--|
|  75° TCBNR / L | T Sistem/T System 2525 M16 |  75° TCKNR / L | T Sistem/T System 2020 K12 2525 M12 3232 P12 2525 M16 3232 P16 |  95° TCLNR / L | T Sistem/T System 2020 K12 2525 M12 3232 P12 4040 S12 5050 S12 2525 M16 3232 P16 |
|  50° TCMNN | T Sistem/T System 1616 H12 2020 K12 2525 M12 3232 P12 2525 M16 3232 P16 |  40° TCZNN | T Sistem/T System 2020 K12 2525 M12 3232 P12 2525 M16 3232 P16 |  107.5° TDHNR / L | T Sistem/T System 2525 M11 2020 K15 2525 M15 3232 P15 |
|  93° TDJNR / L | T Sistem/T System 1616 H11 2020 K11 2525 M11 2020 K15 2525 M15 3232 P15 4040 S15 2020 K1504 2525 M1504 3232 P1504 4040 S1504 | |  62.5° TDNNN | T Sistem/T System 1616 H11 2020 K11 2525 M11 2020 K15 2525 M15 3232 P15 | |
|  45° TSDNN | T Sistem/T System 1616 H12 2020 K12 2525 M12 3232 P12 3232 P15 |  75° TSKNR / L | T Sistem/T System 2020 K12 2525 M12 3232 P12 3232 P15 |  45° TSSNR / L | T Sistem/T System 2020 K12 2525 M12 3232 P12 2525 M15 3232 P15 |
|  60° TTENN | T Sistem/T System 2020 K16 2525 M16 3232 P16 2525 M22 3232 P22 |  90° TTGNR / L | T Sistem/T System 2020 K16 2525 M16 3232 P16 2525 M22 3232 P22 4040 S22 |  93° TTJNR / L | T Sistem/T System 2020 K16 2525 M16 3232 P16 2525 M22 3232 P22 |
|  107.5° TVHNR / L | T Sistem/T System 2020 K16 2525 M16 3232 P16 |  93° TVJNR / L | T Sistem/T System 2020 K16 2525 M16 3232 P16 |  72.5° TVVNN | T Sistem/T System 2020 K16 2525 M16 3232 P16 |

| | | |
|---|--|--|
|  <p>T Sistem/T System</p> <p>1616 H06 2020 K06 2525 M06 2020 K08 2525 M08 3232 P08 4040 S08</p> <p>95° TWLNR / L</p> | <p>T-Sistem İçten Soğutma Kanallı Dış Torna Katerleri / T-System External Turning Toolholders With Coolant Hole</p>  <p>T Sistem/T System</p> <p>2020 K12-H 2525 M12-H 3232 P12-H</p> <p>95° TCLNR/L</p> |  <p>T Sistem/T System</p> <p>2020 K15-H 2525 M15-H 3232 P15-H</p> <p>93° TDJNR/L</p> |
|  <p>T Sistem/T System</p> <p>2525 M15-H</p> <p>62.5° TDNNN</p> |  <p>T Sistem/T System</p> <p>2020 K08-H 2525 M08-H 3232 P08-H</p> <p>95° TWLNR/L</p> |  <p>M Sistem/M System</p> <p>2020 K16 2525 M16 3232 P16 2525 M22 3232 P22 4040 S22</p> <p>60° MTENN</p> |
|  <p>M Sistem/M System</p> <p>2020 K16 2525 M16 3232 P16</p> <p>93° MTJNR / L</p> | <p>2525 M22 3232 P22 4040 S22</p> |  <p>M Sistem/M System</p> <p>1616 H06 2020 K06 2525 M06</p> <p>2020 K08 2525 M08 3232 P08</p> <p>95° MWLNR / L</p> |
|  <p>M Sistem/M System</p> <p>1616 H06 2020 K06 2525 M06</p> <p>50° MWMNN</p> | <p>2020 K08 2525 M08 3232 P08</p> |  <p>P Sistem/P System</p> <p>2020 K12C 2525 M12C 3232 P12C 2525 M16C 3232 P16C</p> <p>2020 K12C 3232 P19C 4040 S19C 4040 S25C</p> <p>75° PCBNR / L</p> |
|  <p>P Sistem/P System</p> <p>1616 H09 2020 K09 2525 M09 1616 H12 2020 K12C 2525 M12C 3232 P12C</p> <p>2525 M16C 3232 P16C 2525 M19C 3232 P19C 4040 S19C 4040 S25C 5050 S25C</p> <p>95° PCLNR / L</p> | <p>50° PCMNN</p> |  <p>P Sistem/P System</p> <p>2020 K12C 2525 M12C 3232 P19C 4040 S19C 4040 S25C</p> |
|  <p>P Sistem/P System</p> <p>1616 H11 2020 K11 2525 M11 2020 K15C 2525 M15C 3232 P15C 4040 S15C</p> <p>93° PDJNR / L</p> |  <p>P Sistem/P System</p> <p>1616 H11 2020 K11 2525 M11 2020 K15C 2525 M15C 3232 P15C</p> <p>62.5° PDNNN</p> |  <p>P Sistem/P System</p> <p>1616 H09 2020 K12C 2525 M12C 3232 P12C 2525 M15 3232 P15C 3232 P19C 4040 S19C 4040 S25C 5050 S25C</p> <p>75° PSBNR / L</p> |

Dış Çap Tornalama Katerleri / External Turning Toolholders

| | | | | |
|---|---|--|---|--|
|  <p>45° PSDNN</p> | <p>P Sistem/P System</p> <p>1616 H09 2020 K12C 2525 M12C 3232 P12C</p> <p>2525 M15C 3232 P19C 4040 S25C</p> |  <p>75° PSKNN / L</p> | <p>P Sistem/P System</p> <p>2020 K09 2020 K12C 2525 M12C 3232 P12C 2525 M15C 3232 P15C</p> <p>3232 P19C 4040 S19C 4040 S25C 5050 S25C</p> | |
|  <p>45° PSSNR / L</p> | <p>P Sistem/P System</p> <p>1616 H09 2020 K09 2020 K12C 2525 M12C</p> <p>3232 P12C 3232 P15C 3232 P19C 4040 S19C 4040 S25C</p> |  <p>90° PTFNR / L</p> | <p>P Sistem/P System</p> <p>1616 H16 2020 K16 2525 M16 3232 P16</p> <p>2525 M22C 3232 P22C</p> | |
|  <p>90° PTGNN / L</p> | <p>P Sistem/P System</p> <p>1616 H16 2020 K16 2525 M16 2525 M22C 3232 P22C</p> |  <p>93° PTJNN / L</p> | <p>P Sistem/P System</p> <p>1616 H16 2020 K16 2525 M16 3232 P16 2525 M22C 3232 P22C 4040 S27</p> |  <p>60° PTTNN / L</p> <p>1616 H16 2020 K16 2525 M16 3232 P16 2525 M22C 3232 P22C</p> |
|  <p>95° PWNLR / L</p> | <p>P Sistem/P System</p> <p>1616 H06 2020 K06 2525 M06 1616 H08 2020 K08C 2525 M08C 3232 P08C</p> | <p>P-Sistem İçten Soğutma Kanallı Dış Torna Katerleri / P-System External Turning Toolholders With Coolant Hole</p>  <p>95° PCLNN/L</p> <p>P Sistem/P System</p> <p>2020 K12-H 2525 M12-H 3232 P12-H</p>  <p>93° PDJNN/L</p> <p>P Sistem/P System</p> <p>2020 K15-H 2525 M15-H 3232 P15-H</p> | | |
|  <p>93° PDNNN</p> | <p>P Sistem/P System</p> <p>2525 M15-H</p> |  <p>95° PWNLR/L</p> | <p>P Sistem/P System</p> <p>2020 K08-H 2525 M08-H</p> |  <p>93° CKJNN / L</p> <p>C Sistem/C System</p> <p>2020 K16 2525 M16 3232 P16 4040 S16</p> |
|  <p>95° CCLNN / L</p> | <p>C Sistem Seramik / C System Ceramic</p> <p>2525 M1207C 3232 P1207C 2525 M1607C</p> |  <p>0° CRDCN</p> | <p>C Sistem Seramik / C System Ceramic</p> <p>2525 M06CV 3225 P06CV 4040 S06CV</p> <p>2525 M09CV 3225 P09CV 4040 S09CV</p> <p>2525 M12CV 3225 P12CV 4040 S12CV</p> | |

| | | | | | |
|---|---|--|---|---|---|
|  <p>CRDCR / L</p> | <p>C Sistem Seramik <i>C System Ceramic</i></p> <p>3225 P06CV 3225 P09CV 3225 P12CV</p> |  <p>CDJNR / L</p> | <p>C Sistem Seramik <i>C System Ceramic</i></p> <p>2525 M1107C 2525 M1507C 3232 P1507C</p> |  <p>CDNNN</p> | <p>C Sistem Seramik <i>C System Ceramic</i></p> <p>2525 M1107C</p> |
|  <p>CSDNN</p> | <p>C Sistem Seramik <i>C System Ceramic</i></p> <p>2525 M1207C 3232 P1207C</p> |  <p>CSKNR / L</p> | <p>C Sistem Seramik <i>C System Ceramic</i></p> <p>2525 M1207C 3232 P1207C</p> |  <p>CSRNR / L</p> | <p>C Sistem Seramik <i>C System Ceramic</i></p> <p>2525 M1207C 3232 P1207C</p> |
|  <p>CSSNR / L</p> | <p>C Sistem Seramik <i>C System Ceramic</i></p> <p>2525 M1207C 3232 P1207C</p> |  <p>CTJNR / L</p> | <p>C Sistem Seramik <i>C System Ceramic</i></p> <p>2525 M1607C 3232 P1607C</p> |  <p>SCACR / L</p> | <p>C Sistem Seramik <i>C System Ceramic</i></p> <p>0808 E06 1010 E06 1212 F09 1616 H09 2020 K09 2020 K12 2525 M12-Z 2525 M12</p> |
|  <p>SCMCN</p> | <p>S Sistem/S System</p> <p>0808 E06 1010 E06 1212 F06 1212 F09</p> <p>1616 H09 2020 K12 2525 M12</p> | |  <p>SCLCR / L</p> | <p>S Sistem/S System</p> <p>0808 E06 1010 E06 1212 F06 1010 E09 1212 F09 1616 H09 2020 K09</p> <p>2525 M09 1616 H12 2020 K12-Z 2020 K12 2525 M12-Z 2525 M12</p> | |
|  <p>SDHCR / L</p> | <p>S Sistem/S System</p> <p>0808 E07 1010 E07 1212 F07 1616 H07 1616 H11 2020 K11 2525 M 11 3232 P11</p> | |  <p>SDJCR / L</p> | <p>S Sistem/S System</p> <p>0808 E07 1010 E07 1212 F07 1616 H07 1616 H11 2020 K11 2525 M 11 3232 P11</p> | |
|  <p>SRDCR / L</p> | <p>S Sistem/S System</p> <p>3232 P12C</p> | |  <p>SRDCN</p> | <p>S Sistem/S System</p> <p>1616 H06 2020 K06 2525 M06 1616 H08C 2020 K08C 2525 M08C</p> <p>1616 H10C 2020 K10C 2525 M10C 3232 P10C 2020 K12C 2525 M12C 3232 P12C</p> <p>2525 M16C 3232 P16C 2525 M20C 3232 P20C 3232 P25C 3232 P32C</p> | |

Diş Çap Tornalama Katerleri / External Turning Toolholders

| | | | |
|---|--|--|---|
|  <p>-° SRGCR / L</p> | <p><i>S Sistem/S System</i></p> <p>1616 H06 2020 K06 1616 H08C 2020 K08C 2525 M08C</p> <p>1616 H10C 2020 K10C 2525 M10C 3232 P10C</p> <p>2020 K12C 2525 M12C 3232 P12C</p> |  <p>20° SRHCR / L</p> <p><i>S Sistem/S System</i></p> <p>2525 K06 2525 K08 2525 K10 2525 K12 2525 K16</p> | |
|  <p>-° SRXCR / L</p> | <p><i>S Sistem/S System</i></p> <p>3232 X08C 3232 X10C 3232 X12C</p> |  <p>45° SSDCN</p> <p><i>S Sistem/S System</i></p> <p>1212 F09 1616 H09-Z 1616 H09 2020 K09-Z 2020 K09 1616 H12-Z 1616 H12 2020 K12 2525 M12</p> |  <p>90° STGCR / L</p> <p><i>S Sistem/S System</i></p> <p>0808 E09 1010 E09 1212 F11 1616 H11 1616 H16 2020 K16 2525 M16 3232 P16</p> |
|  <p>45° SSSCR / L</p> | <p><i>S Sistem/S System</i></p> <p>1212 F09 1616 H09-Z 1616 H09 2020 K09-Z 2020 K09</p> <p>1616 H12 2020 K12-Z 2020 K12 2525 M12-Z 2525 M12</p> |  <p>90° STFGR / L</p> <p><i>S Sistem/S System</i></p> <p>0808 E09 1010 E09 1212 F11 1616 H11</p> <p>1616 H16 2020 K16 2525 M16 3232 P16</p> | |
|  <p>93° STJCR / L</p> | <p><i>S Sistem/S System</i></p> <p>0808 E09 1010 E09 1212 F11 1616 H11 1616 H16 2020 K16 2525 M16 3232 P16</p> |  <p>90° STCCN</p> <p><i>S Sistem/S System</i></p> <p>2020 L11 2525 M11 1616 K16 2020 M16 2525 P16 3232 R16 2525 P22</p> |  <p>93° STUCR / L</p> <p><i>S Sistem/S System</i></p> <p>0808 E09 1010 E09 1212 F11 1616 H11 2020 K16 2525 M16 3232 P16</p> |
|  <p>107.5° SVHBR / L</p> | <p><i>S Sistem/S System</i></p> <p>1212 F11 1616 H11 2020 K11 2020 K16 2525 M16 3232 P16</p> |  <p>107.5° SVHCR / L</p> <p><i>S Sistem/S System</i></p> <p>1212 F11 1616 H11 2020 K11 2020 K16 2525 M16 3232 P16</p> |  <p>93° SVJBR / L</p> <p><i>S Sistem/S System</i></p> <p>1212 F11 1616 H11 2020 K11 1616 H16 2020 K16 2525 M16 3232 P16</p> |
|  <p>93° SVJCR / L</p> | <p><i>S Sistem/S System</i></p> <p>1212 F11 1616 H11 2020 K11 2525 M11 1212 F16 2020 K16 2525 M16 3232 P16</p> |  <p>72.5° SVVBN</p> <p><i>S Sistem/S System</i></p> <p>1212 F11 1616 H11 2020 K11 2020 K16 2525 M16 3232 P16</p> |  <p>72.5° SVVCN</p> <p><i>S Sistem/S System</i></p> <p>1212 F11 1616 H11 2020 K11 2020 K16 2525 M16 3232 P16</p> |

| | | | |
|---|--|--|---|
|  <p>90° SCACR / L</p> | <p>S Sistem İsviçre Tipi / S System Swiss Type</p> <p>0808 X06-S 1010 K06-S 1212 G06-S 1212 K06-S</p> <p>1212 K09-S 1616 K09-S 2020 K09-S</p> |  <p>90° SDACR / L</p> | <p>S Sistem İsviçre Tipi / S System Swiss Type</p> <p>0808 X07-S 1010 K07-S 1212 K07-S 1616 F07-S 1616 K07-S</p> <p>1212 K11-S 1616 F11-S 1616 K11-S 2020 K11-S</p> |
|  <p>91° STGCR / L</p> | <p>S Sistem İsviçre Tipi / S System Swiss Type</p> <p>1216 K11-S 1616 K11-S 1216 K16-S 1616 K16-S</p> |  <p>95° SCLCR / L</p> | <p>S Sistem İsviçre Tipi / S System Swiss Type</p> <p>0808 X06-S 1010 X06-S 1212 G06-S 1212 X06-S 1212 K06-S 1616 F06-S 1616 X06-S</p> <p>1212 G09-S 1212 X09-S 1616 F09-S 1616 G09-S 1616 X09-S 2020 X09-S</p> |
|  <p>93° SDJCR / L</p> | <p>S Sistem İsviçre Tipi / S System Swiss Type</p> <p>0808 X07-S 1010 X07-S 1212 G07-S 1212 X07-S 1616 F07-S 1616 X07-S 2020 X07-S</p> <p>1212 G11-S 1212 X11-S 1212 K11-S 1616 F11-S 1616 X11-S 1616 K11-S 2020 X11-S</p> |  <p>90° SVACR / L</p> | <p>S Sistem İsviçre Tipi / S System Swiss Type</p> <p>1010 K11-S 1212 K11-S 1616 K11-S 2020 K11-S 1212 K16-S 1616 K16-S</p> |
|  <p>93° SVJBR / L</p> | <p>S Sistem İsviçre Tipi / S System Swiss Type</p> <p>1616 K11-S</p> |  <p>93° SVJCR / L</p> | <p>S Sistem İsviçre Tipi / S System Swiss Type</p> <p>0808 X11-S 1010 K11-S 1212 K11-S 1616 K11-S</p> |

| | | | | | |
|--|---|---|---|---|---|
|  <p>- ASTB</p> | <p>SEC Tools</p> <p>1212-L84-H 1616-L90-H</p> |  <p>93° SDJCR / L</p> | <p>SEC Tools</p> <p>12X43.3-07 12X43.3-07-H 16X43.3-07 16X43.3-07-H 12X43.3-11 12X43.3-11-H 16X43.3-11 16X43.3-11-H</p> |  <p>93° SVJCR / L</p> | <p>SEC Tools</p> <p>12-43.3-11 12-43.3-11-H 16-43.3-11 16-43.3-11-H</p> |
|--|---|---|---|---|---|

| | |
|---|--|
|  <p>- SER/L</p> | <p>SEC Tools</p> <p>12x43.3-11 16x43.3-11 16x43.3-16</p> |
|---|--|



DETAYLI BİLGİ İÇİN BARKODU OKUTUNUZ
SCAN ME FOR MORE DETAILS

Delik İçi Tornalama Katerleri / Boring Bars



T Sistem/T System

S25S TCLNR/L 09-Z
S25S TCLNR/L 09
S25S TCLNR/L 12-Z
S25S TCLNR/L 12

S32T TCLNR/L 12
S40U TCLNR/L 12
S50V TCLNR/L 12

S32T TCLNR/L 16
S40U TCLNR/L 16
S50V TCLNR/L 16

95° **TCLNR / L**



T Sistem/T System

S32T TD-NR/L 15
S40U TD-NR/L 15
S50V TD-NR/L 15

62.5° **TD-NR / L**



T Sistem/T System

S25S TDQNR/L 11-Z
S25S TDQNR/L 11
S32T TDQNR/L 11
S25S TDQNR/L 15
S32T TDQNR/L 15
S40U TDQNR/L 15
S50V TDQNR/L 15

107.5° **TDQNR / L**



T Sistem/T System

S25S TDUNR/L 11-Z
S25S TDUNR/L 11
S32T TDUNR/L 11
S25S TDUNR/L 15
S32T TDUNR/L 15
S40U TDUNR/L 15
S50V TDUNR/L 15

93° **TDUNR / L**



T Sistem/T System

S25S TSKNR/L 12-Z
S25S TSKNR/L 12
S32T TSKNR/L 12
S40U TSKNR/L 12

75° **TSKNR / L**



T Sistem/T System

S25S TT-NR/L 16-Z
S25S TT-NR/L 16
S32T TT-NR/L 16

60° **TT-NR / L**



T Sistem/T System

S25S TTUNR/L 16-Z
S25S TTUNR/L 16
S32T TTUNR/L 16
S25S TTUNR/L 22
S32T TTUNR/L 22
S40U TTUNR/L 22
S50V TTUNR/L 22

93° **TTUNR / L**



T Sistem/T System

S25S TVUNR/L 16
S32T TVUNR/L 16
S40U TVUNR/L 16

93° **TVUNR / L**



T Sistem/T System

S25S TWLNR/L 06-Z
S25S TWLNR/L 06
S32T TWLNR/L 06
S25S TWLNR/L 08-Z

S25S TWLNR/L 08
S32T TWLNR/L 08
S40U TWLNR/L 08
S50V TWLNR/L 08

A32S TWLNR/L 08
A40T TWLNR/L 08
A50U TWLNR/L 08

95° **TWLNR / L**



C Sistem/C System

S25S CKUNR/L 16
S32T CKUNR/L 16
S40U CKUNR/L 16
S50V CKUNR/L 16

93° **CKUNR / L**



M Sistem/M System

S20R MCLNR/L 12
S25S MCLNR/L 12-Z
S25S MCLNR/L 12
S32T MCLNR/L 12

95° **MCLNR / L**



M Sistem/M System

S20R MDUNR/L 11
S25S MDUNR/L 11
S25S MDUNR/L 15-Z
S25S MDUNR/L 15
S32T MDUNR/L 15
S40U MDUNR/L 15
S50V MDUNR/L 15

93° **MDUNR / L**



M Sistem/M System

S20R MTFNR/L 16
S25S MTFNR/L 16
S32T MTFNR/L 16
S40U MTFNR/L 16
S32T MTFNR/L 22
S40U MTFNR/L 22
S50V MTFNR/L 22

90° **MTFNR / L**



M Sistem/M System

S20R MT-NR/L 16
S25S MT-NR/L 16-Z
S25S MT-NR/L 16
S32T MT-NR/L 16
S40U MT-NR/L 16
S32T MT-NR/L 22
S40U MT-NR/L 22
S50U MT-NR/L 22

60° **MT-NR / L**



M Sistem/M System

S20R MTQNR/L 16
S25S MTQNR/L 16-Z
S25S MTQNR/L 16
S32T MTQNR/L 16
S40U MTQNR/L 16
S32T MTQNR/L 22
S40U MTQNR/L 22
S50V MTQNR/L 22

107.5° **MTQNR / L**



M Sistem/M System

S20R MTUNR/L 16
S25S MTUNR/L 16-Z
S25S MTUNR/L 16
S32T MTUNR/L 16
S40U MTUNR/L 16
S50V MTUNR/L 16
S32T MTUNR/L 22
S40U MTUNR/L 22
S50V MTUNR/L 22

93° **MTUNR / L**



M Sistem/M System

S16P MWLNR/L 06
S20R MWLNR/L 06
S25S MWLNR/L 06
S25S MWLNR/L 08-Z
S25S MWLNR/L 08
S32T MWLNR/L 08
S40U MWLNR/L 08

95° **MWLNR / L**



P Sistem/P System

S16P PCLNR/L 09
S20R PCLNR/L 09
S25S PCLNR/L 09
S25S PCLNR/L 12C
S32T PCLNR/L 12C
S40U PCLNR/L 12C
S50V PCLNR/L 12C
S32T PCLNR/L 16C

95° **PCLNR / L**

S40U PCLNR/L 16C
S50V PCLNR/L 16C
S40U PCLNR/L 19C
S50V PCLNR/L 19C
A20P PCLNR/L 09
A25R PCLNR/L 12C
A32S PCLNR/L 12C
A40T PCLNR/L 12C
A50U PCLNR/L 12C
A32S PCLNR/L 16C
A40T PCLNR/L 16C
A50U PCLNR/L 16C
A40T PCLNR/L 19C
A50U PCLNR/L 19C



P Sistem/P System

S20R PDQNR/L 11 S32T PDQNR/L 1504 A32S PDQNR/L 15
S25S PDQNR/L 11 S40U PDQNR/L 1504 A40T PDQNR/L 15
S32T PDQNR/L 15 S50V PDQNR/L 1504 A50U PDQNR/L 15
S40U PDQNR/L 15 A20P PDQNR/L 11 A32S PDQNR / L 1504
S50V PDQNR/L 15 A25R PDQNR/L 11 A40T PDQNR / L 1504

107.5° **PDQNR / L**



P Sistem/P System

S20R PDUNR/L 11 A20P PDUNR/L 11
S25S PDUNR/L 11 A25R PDUNR/L 11
S25S PDUNR/L 15 A32S PDUNR/L 11
S32T PDUNR/L 15 A32S PDUNR/L 15
S40U PDUNR/L 15 A40T PDUNR/L 15
S50V PDUNR/L 15 A50U PDUNR/L 15

93° **PDUNR / L**



P Sistem/P System

S32T PDXNR/L 15
S40U PDXNR/L 15
S50V PDXNR/L 15

93° **PDXNR / L**



P Sistem/P System

S25S PSKNR/L 12C
S32T PSKNR/L 12C
S40U PSKNR/L 12C
S50V PSKNR/L 12C
S32T PSKNR/L 15C
S40U PSKNR/L 15C
S50V PSKNR/L 15C
A25R PSKNR/L 12C
A32S PSKNR/L 12C
A40T PSKNR/L 12C
A50U PSKNR/L 12C
A32S PSKNR/L 15C
A40T PSKNR/L 15C
A50U PSKNR/L 15C

75° **PSKNR / L**



P Sistem/P System

S16P PTUNR/L 16
S20R PTUNR/L 16
S25S PTUNR/L 16C
S32T PTUNR/L 16C
S40U PTUNR/L 16C
S32T PTUNR/L 22C
S40U PTUNR/L 22C
S50V PTUNR/L 22C
A16M PTUNR/L 16
A20P PTUNR/L 16
A25R PTUNR/L 16C
A32S PTUNR/L 16C
A40T PTUNR/L 16C
A32S PTUNR/L 22C
A40T PTUNR/L 22C

93° **PTUNR / L**



P Sistem/P System

A25R PTFNR/L 16C
A32S PTFNR/L 16C

90° **PTFNR / L**



P Sistem/P System

S20R PWLNR/L 06
S25S PWLNR/L 06
S32T PWLNR/L 06

95° **PWLNR / L**

S25S PWLNR/L 08C
S32T PWLNR/L 08C
S40U PWLNR/L 08C
S50V PWLNR/L 08C
A16M PWLNR/L 06
A20P PWLNR/L 06
A25R PWLNR/L 06
A32S PWLNR/L 06
A40T PWLNR/L 06C
A25R PWLNR/L 08C
A32S PWLNR/L 08C
A40T PWLNR/L 08C
A50U PWLNR/L 08C



S Sistem/S System

S08H SCFCR/L 06
S10K SCFCR/L 06
S12K SCFCR/L 06

90° **SCFCR / L**

S12K SCFCR/L 09
S16P SCFCR/L 09
S20R SCFCR/L 09

S25S SCFCR/L 09-Z
S25S SCFCR/L 09
S25S SCFCR/L 12



S Sistem/S System

S10K SD-CR/L 07
S12K SD-CR/L 07
S16P SD-CR/L 07
S20R SD-CR/L 07
S16P SD-CR/L 11
S20R SD-CR/L 11
S25S SD-CR/L 11-Z
S25S SD-CR/L 11
S32T SD-CR/L 11
S40U SD-CR/L 11

62.5° **SD-CR / L**



S Sistem/S System

S0608H SCLCR/L 03 S12K SCLCR/L 09 S32T SCLCR/L 09 A12H SCLCR/L 06
S0608H SCLCR/L 06 S1416P SCLCR/L 09 S25S SCLCR/L 12-Z A16M SCLCR/L 09
S08H SCLCR/L 06 S16P SCLCR/L 09 S25S SCLCR/L 12 A20P SCLCR/L 09
S10K SCLCR/L 06 S1620R SCLCR/L 09 S32T SCLCR/L 12 A25R SCLCR/L 09
S12K SCLCR/L 06 S20R SCLCR/L 09 S40U SCLCR/L 12 A32S SCLCR/L 09
S1216P SCLCR/L 06 S25S SCLCR/L 09-Z A08H SCLCR/L 06 A25R SCLCR/L 12
S16P SCLCR/L 06 S25S SCLCR/L 09 A10H SCLCR/L 06

95° **SCLCR / L**



S Sistem/S System

S10K SDPCR/L 07
S12K SDPCR/L 07
S16P SDPCR/L 11
S20R SDPCR/L 11
S25S SDPCR/L 11

117.5° **SDPCR / L**

Delik İçi Tornalama Katerleri / Boring Bars



S Sistem/S System

S16P SRGCR/L 08
S20R SRGCR/L 08
S25S SRGCR/L 08C
S32T SRGCR/L 08C
S40U SRGCR/L 08C
A16M SRGCR/L 08
A20P SRGCR/L 08
A25R SRGCR/L 08C
A32S SRGCR/L 08C
A40T SRGCR/L 08C

-° **SRGCR / L**



S Sistem/S System

S10K SDQCR/L 07
S12K SDQCR/L 07
S16P SDQCR/L 07
S20R SDQCR/L 07

107.5° **SDQCR / L**

S16P SDQCR/L 11
S20R SDQCR/L 11
S25S SDQCR/L 11-Z
S25S SDQCR/L 11
S32T SDQCR/L 11
S40U SDQCR/L 11

A10H SDQCR/L 07
A12H SDQCR/L 07
A16M SDQCR/L 07
A20P SDQCR/L 07
A16M SDQCR/L 11
A20P SDQCR/L 11
A25R SDQCR/L 11
A32S SDQCR/L 11



S Sistem/S System

S0810K SDUCR/L 07
S10K SDUCR/L 07
S12K SDUCR/L 07
S1216P SDUCR/L 07
S1416P SDUCR/L 07
S16P SDUCR/L 07
S20R SDUCR/L 07

93° **SDUCR / L**

S1416P SDUCR/L 11
S16P SDUCR/L 11
S1620R SDUCR/L 11
S20R SDUCR/L 11
S25S SDUCR/L 11-Z
S25S SDUCR/L 11
S32T SDUCR/L 11

S40U SDUCR/L 11
S50V SDUCR/L 11
A0810H SDUCR/L 07
A10H SDUCR/L 07
A12H SDUCR/L 07
A16M SDUCR/L 07
A20P SDUCR/L 07

A16M SDUCR/L 11
A20P SDUCR/L 11
A25R SDUCR/L 11
A32S SDUCR/L 11



S Sistem/S System

S12K SDXCR/L 07
S16P SDXCR/L 07
S20R SDXCR/L 07
S16P SDXCR/L 11
S20R SDXCR/L 11
S25S SDXCR/L 11
S32T SDXCR/L 11
S40U SDXCR/L 11
A12H SDXCR/L 07
A16M SDXCR/L 07
A20P SDXCR/L 07
A16M SDXCR/L 11
A20P SDXCR/L 11
A25R SDXCR/L 11
A32S SDXCR/L 11

93° **SDXCR / L**



S Sistem/S System

S16P SSSCR/L 09
S20R SSSCR/L 09
S25S SSSCR/L 09
S25S SSSCR/L 09-Z
S25S SSSCR/L 12
S32T SSSCR/L 12
S40U SSSCR/L 12

45° **SSSCR / L**



S Sistem/S System

S12K ST-CR/L 11
S16P ST-CR/L 11
S20R ST-CR/L 11
S16P ST-CR/L 16
S20R ST-CR/L 16
S25S ST-CR/L 16-Z
S25S ST-CR/L 16
S32T ST-CR/L 16
S40U ST-CR/L 16

60° **ST-CR / L**



S Sistem/S System

S0610F STFCR/L 06
S08H STFCR/L 06
S10K STFCR/L 09
S12K STFCR/L 09
S12K STFCR/L 11
S16P STFCR/L 11
S20R STFCR/L 16
S25S STFCR/L 16-Z
S25S STFCR/L 16
S32T STFCR/L 16
A10H STFCR/L 11
A12H STFCR/L 11
A16M STFCR/L 11

90° **STFCR / L**



S Sistem/S System

S10K STUCR/L 09
S12K STUCR/L 09
S12K STUCR/L 11
S16P STUCR/L 11
S20R STUCR/L 11
S16P STUCR/L 16
S20R STUCR/L 16
S25S STUCR/L 16
S32T STUCR/L 16
S40U STUCR/L 16
A10H STUCR/L 09
A12H STUCR/L 09
A12H STUCR/L 11
A16M STUCR/L 11
A20P STUCR/L 11
A16M STUCR/L 16
A20P STUCR/L 16
A25R STUCR/L 16
A32S STUCR/L 16

93° **STUCR / L**



S Sistem/S System

S08H STUPR/L 0802
S10K STUPR/L 1103
S12K STUPR/L 1103
S12M STUPR/L 1103
S16P STUPR/L 1103
S16R STUPR/L 1103
A20R STUPR/L 1103

93° **STUPR / L**



S Sistem/S System

S25S SVJBR/L 16
S32T SVJBR/L 16
S40U SVJBR/L 16

93° **SVJBR / L**



S Sistem/S System

S12K SVJCR/L 11
S16P SVJCR/L 11
S20R SVJCR/L 11
A12H SVJCR/L 11
A16M SVJCR/L 11
A20P SVJCR/L 11

93° **SVJCR / L**



S Sistem/S System

S16P SVQBR/L 11
S20R SVQBR/L 11
S25S SVQBR/L 16-Z
S25S SVQBR/L 16
S32T SVQBR/L 16
S40U SVQBR/L 16
A20Q SVQBR/L 11
A20Q SVQBR/L 16
A25S SVQBR/L 16
A32S SVQBR/L 16

107.5° **SVQBR / L**



S Sistem/S System

S16P SVQCR/L 11
S20R SVQCR/L 11
S25S SVQCR/L 16
S32T SVQCR/L 16
S40U SVQCR/L 16
A16M SVQCR/L 11
A20P SVQCR/L 11
A25R SVQCR/L 16
A32S SVQCR/L 16
A40T SVQCR/L 16

107.5° **SVQCR / L**



S Sistem/S System

S16P SVUBR/L 11
S20R SVUBR/L 11
S25S SVUBR/L 16-Z
S25S SVUBR/L 16
S32T SVUBR/L 16
S40U SVUBR/L 16
A20Q SVUBR/L 16
A32S SVUBR/L 16

93° **SVUBR / L**

Delik İçi Tornalama Katerleri / Boring Bars

| | | |
|---|---|---|
|  <p>S Sistem/S System S16P SVUCR/L 11 S20R SVUCR/L 11 S25S SVUCR/L 16-Z S32T SVUCR/L 16 S40U SVUCR/L 16 A12K SVUCR/L 07 A20Q SVUCR/L 11 A25R SVUCR/L 16</p> <p>93° SVUCR / L</p> |  <p>S Sistem/S System S16P SVXBR/L 1102 S20R SVXBR/L 1102 S16P SVXBR/L 11 S20R SVXBR/L 11 S25S SVXBR/L 16 S32T SVXBR/L 16 S40U SVXBR/L 16</p> <p>93° SVXBR / L</p> |  <p>S Sistem/S System S0608H SWLCR 03 S0810K SWLCR 03</p> <p>95° SWLCR</p> |
|  <p>S Sistem/S System S08H SWUBR 06-5.5 S08H SWUBR 06-7 S0610H SWUBR 06</p> <p>93° SWUBR</p> |  <p>S Sistem Karbür Şaftlı S System Carbide Shank C06J SCLCR/L 06 E08K SCLCR/L 06 E10M SCLCR/L 06 E12Q SCLCR/L 06 E16R SCLCR/L 09 E20S SCLCR/L 09</p> <p>95° SCLCR / L</p> |  <p>S Sistem Karbür Şaftlı S System Carbide Shank E10M SDUCR/L 07 E12Q SDUCR/L 07 E16R SDUCR/L 11 E20S SDUCR/L 11</p> <p>93° SDUCR / L</p> |
|  <p>S Sistem/S System E10M STFCR/L 09 E12Q STFCR/L 09 E12Q STFCR/L 11</p> <p>90° STFCR/L</p> |  <p>S Sistem/S System E12Q STUPR/L 1103 E16R STUPR/L 1103</p> <p>93° STUPR/L</p> | |

S-Sistem Delik İçi Tornalama Kater Setleri / S-System Boring Bars Sets

| | | |
|---|---|---|
|  <p>S Sistem/S System A08H SCLCR/L 06 A10H SCLCR/L 06 A12H SCLCR/L 06 A16M SCLCR/L 09</p> <p>95° SET-A/SCLCR/L</p> |  <p>S Sistem/S System E08K SCLCR/L 06 E10M SCLCR/L 06 E12Q SCLCR/L 06 E16R SCLCR/L 09</p> <p>95° SET-E/SCLCR/L</p> |  <p>S Sistem/S System S08H SCLCR/L 06 S10K SCLCR/L 06 S12K SCLCR/L 06 S16P SCLCR/L 09</p> <p>95° SET-S/SCLCR/L</p> |
|  <p>S Sistem/S System A10H SDUCR/L 07 A12H SDUCR/L 07 A16M SDUCR/L 11</p> <p>93° SET-A/SDUCR/L</p> |  <p>S Sistem/S System E10M SDUCR/L 07 E12Q SDUCR/L 07 E16R SDUCR/L 11</p> <p>93° SET-E/SDUCR/L</p> |  <p>S Sistem/S System S10K SDUCR/L 07 S12K SDUCR/L 07 S16P SDUCR/L 11</p> <p>93° SET-S/SDUCR/L</p> |

Kartuşlar / Cartridges

S Sistem/S System

S10X SCACR/L 06
S10A SCACR/L 06
S1018 SCACR/L 06
S1065 SCACR/L 06
S10C SCACR/L 06
S12B SCACR/L 06
S12D SCACR/L 06
S12D SCACR/L 09

S1265 SCACR/L 09
S12H SCACR/L 09
S15C SCACR/L 09
S1554 SCACR/L 09
S15E SCACR/L 09
S15D SCACR/L 09
S16A SCACR/L 09
S16B SCACR/L 09

S16C SCACR/L 09
S16D SCACR/L 09
S16E SCACR/L 09
S16G SCACR/L 09
S16H SCACR/L 09
S1868 SCACR/L 09
S18E SCACR/L 09
S1888 SCACR/L 09

S18105 SCACR/L 09
S18175 SCACR/L 09
S20E SCACR/L 09
S20E SCACR/L 12
S20H SCACR/L 12

90° **SCACR / L**

S Sistem/S System

S10X SCMCN 06
S12D SCMCN 06
S16C SCMCN 09
S16D SCMCN 09

S Sistem/S System

S12D SRSCN 10
S14D SRSCN 10
S16D SRSCN 10

S Sistem/S System

STXCR/L 2020 B16
STXCR/L 2020 E16
STXCR/L 2020 B16-SA
STXCR/L 2020 E16-SA
STXCR/L 2020 B16-PL
STXCR/L 2020 E16-PL
STXCR/L 2020 H16-PL

50° **SCMCN**

- **SRSCN**

-° **STXCR / L**

S Sistem/S System

06CA 06
08CA 06
10CA 09
12CA 12
16CA 12

S Sistem/S System

06CA 06
10CA 09
12CA 12

S Sistem/S System

10CA 09
12CA 12

90° **SCFCR / L**

45° **SCSCR / L**

75° **SSKCR / L**

S Sistem/S System

08CA 09
10CA 11
12CA 16
16CA 16

S Sistem/S System

08CA 09
10CA 11
12CA 16

S Sistem/S System

08CA 09
10CA 11

90° **STFCR / L**

45° **STSCR / L**

60° **STTCR / L**

P Sistem/P System

16CA 12

P Sistem/P System

12CA 16
16CA 16

P Sistem/P System

16CA 12

75° **PSKNR / L**

90° **PTFNR / L**

75° **PSRNR / L**

P Sistem/P System

S22D PSDNN 12C

45° **PSDNN**



ATTB

Tırlamaz Takımların Gövdesi / Anti Vibration Tools Shank

ATTB-D16-156-7D-H
ATTB-D16-204-10D-H-E
ATTB-D20-200-7D-H
ATTB-D20-260-10D-H-E
ATTB-D25-255-7D-H
ATTB-D25-330-10D-H
ATTB-D32-320-7D-H

ATTB-D32-416-10D-H
ATTB-D40-408-7D-H
ATTB-D40-528-10D-H
ATTB-D50-519-7D-H
ATTB-D50-669-10D-H
ATTB-D60-628-7D-H
ATTB-D60-808-10D-H



93°

SDUCR / L

Kartuşlar / Cartridges

ATTC-A16 SDUCR/L 07
ATTC-A20 SDUCR/L 11
ATTC-A25 SDUCR/L 11
ATTC-A32 SDUCR/L 11
ATTC-A40 SDUCR/L 11



95°

SCFCR / L

Kartuşlar / Cartridges

ATTC-A16 SCLCR/L 06
ATTC-A20 SCLCR/L 09
ATTC-A25 SCLCR/L 09
ATTC-A32 SCLCR/L 09
ATTC-A40 SCLCR/L 12



93°

SVUCR / L

Kartuşlar / Cartridges

ATTC-A20 SVUCR/L 11
ATTC-A25 SVUCR/L 11
ATTC-A32 SVUCR/L 16
ATTC-A40 SVUCR/L 16



93°

TDUNR / L

Kartuşlar / Cartridges

ATTC-A32 TDUNR/L 11
ATTC-A40 TDUNR/L 15



95°

TCLNR / L

Kartuşlar / Cartridges

ATTC-A32 TCLNR/L 12
ATTC-A40 TCLNR/L 12



93°

ATTC

Merkezeleme Aparatı / Centering Instrument

ATTC-16-25
ATTC-32-60

Boru Pahlama Takımları / Pipe Beveling and Chamfering Tools



| Takım Kodu Tool Code | Dmax | | Dmin | | Max (Out-Din) |
|-------------------------|-------|-------|-------|-------|------------------|
| | D in | D out | D in | D out | |
| ACPBT-1 | 27-52 | 52 | 18-36 | 36 | 27 |
| ACPBT-2 | 27-49 | 52 | 25-36 | 36 | 27 |
| ACPBT-3 | 48-75 | 75 | 41 | 42 | 27 |
| ACPBT-4 | 51-75 | 75 | 51 | 52 | 27 |
| ACPBT-5 | 22-35 | 35 | 22 | 23 | 27 |
| ACPBT-6 | 15-35 | 35 | 15 | 16 | 27 |
| ACPBT-7 | 49-53 | 75 | 32-36 | 36 | 27 |
| ACPBT-8 | 49 | 75 | 33-37 | 37 | 27 |



| Takım Kodu Tool Code | D1 | | D2 |
|-------------------------|------|------|----|
| | Dmax | Dmin | |
| ACPBT-9 | 38 | 24 | 15 |
| ACPBT-10 | 78 | 64 | |
| | 43 | 29 | 1 |

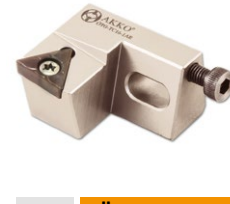

-°

ÖTG-TC..

Takım Adı/Tool Code

ÖTG-TC11-4IL
ÖTG-TC11-4IR
ÖTG-TC16-1AL
ÖTG-TC16-1AR
ÖTG-TC16-2DL
ÖTG-TC16-2DR
ÖTG-TC16-3IL
ÖTG-TC16-3IR

Dış Çap ve Delik İçi Diş Açma Takımları / External and Internal Threading Toolholders



SER / L

Dış Çap Diş Açma İsviçre Tipi Kayar Otomatik Makina Katerleri / External Threading Toolholders For Swiss Type Sliding Automatic Lathes

1010 K11-S
1212 K11-S



SER / L

Dış Çap Diş Açma/External Threading Toolholders

| | | |
|-----------|-----------|-------------|
| 0808 E11 | 2525 M16C | 2525 M16C-T |
| 1010 E11 | 3232 P16C | 2525 M22C-T |
| 1212 F 11 | 2525 M22C | 2020 K16C-S |
| 1616 H11 | 3232 P22C | 2525 M16C-S |
| 2020 H11 | 4040 S22C | 3232 P16C-S |
| 1616 H16C | | |
| 2020 K16C | | |



TER / L

Dış Çap Diş Açma/ External Threading Toolholders

1616 H16
2020 K16
2525 M16
3232 P16
2525 M22
3232 P22
4040 S22
2525 M27
3232 P27
4040 S27



SIR / L

Delik İçi Diş Açma Takımları/Internal Threading Toolholders

| | | |
|------------|------------|------------|
| S12X05H 06 | S16M 16 | S25R 22C |
| S16X05H 06 | S20x16P 16 | S32S 22C |
| S16X07M 08 | S20P 16 | S40T 22C |
| S10H 11 | S25R 16C | S50U 22C |
| S12K 11 | S32S 16C | S25R 16C-T |
| S16X10M 11 | S40T 16C | S32S 16C-T |
| S16X13M 11 | S50U 16C | S25R 22C-T |
| S16M 11 | S20P 22 | S32S 22C-T |
| S16x13M 16 | | |



TIR / L

Delik İçi Diş Açma Takımları/Internal Threading Toolholders

A25R 16
A32S 16
A40T 16
S25R 16
S32S 16
S40T 16
S50U 16
S25R 22
S32S 22
S40T 22
S50U 22
S32S 27
S40T 27
S50U 27

Kesme ve Kanal Açma Uçları / Parting and Grooving Inserts

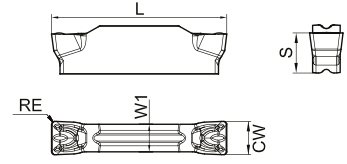

AGD-MT

AKKO Çift Taraflı Kesme Uçları
AKKO Grooving Double Side



| Sipariş Kodu Ordering Code | Ölçü / Dimension (mm) | | | | | Kaplama Karbürleri / Coated Carbides | | |
|-------------------------------|-----------------------|---------|------|------|------|--------------------------------------|--------|--------|
| | CW±0.05 | RE±0.05 | L | W1 | S | AP1225 | AK1115 | AA4230 |
| AGD2002-MT | 2.0 | 0.2 | 16.0 | 1.2 | 3.5 | ● | ● | ● |
| AGD2502-MT | 2.5 | 0.2 | 18.5 | 2.0 | 3.85 | ● | ● | ● |
| AGD3004-MT | 3.0 | 0.4 | 21.2 | 2.35 | 4.8 | ● | ● | ● |
| AGD4004-MT | 4.0 | 0.4 | 21.0 | 3.3 | 4.8 | ● | ● | ● |
| AGD5004-MT | 5.0 | 0.4 | 26.0 | 4.1 | 5.8 | ● | ● | ● |
| AGD5008-MT | 5.0 | 0.8 | 26.0 | 4.1 | 5.8 | ● | ● | ● |
| AGD6004-MT | 6.0 | 0.4 | 26.0 | 5.0 | 5.8 | ● | ● | ● |
| AGD6008-MT | 6.0 | 0.8 | 26.0 | 5.0 | 5.8 | ● | ● | ● |
| AGD8008-MT | 8.0 | 0.8 | 31.0 | 6.0 | 6.5 | ● | ● | ● |

● Stok Stock ○ Talep Edilmesi Halinde Üretilenler Available upon order

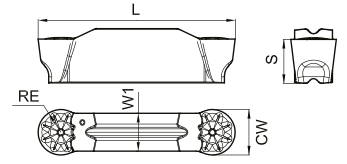

AGD-MR

AKKO Çift Taraflı Kesme Uçları
AKKO Grooving Double Side



| Sipariş Kodu Ordering Code | Ölçü / Dimension (mm) | | | | | Kaplama Karbürleri / Coated Carbides | | | |
|-------------------------------|-----------------------|---------|------|------|-----|--------------------------------------|--------|--------|--------|
| | CW±0.05 | RE±0.05 | L | W1 | S | AP1105 | AP1225 | AK1115 | AA4230 |
| AGD2010-MR | 2.0 | 1.0 | 16.0 | 1.2 | 3.5 | ● | ● | ● | ● |
| AGD3015-MR | 3.0 | 1.5 | 21.2 | 2.35 | 4.8 | ● | ● | ● | ● |
| AGD4020-MR | 4.0 | 2.0 | 21.0 | 3.3 | 4.8 | ● | ● | ● | ● |
| AGD5025-MR | 5.0 | 2.5 | 26.0 | 4.1 | 5.8 | ● | ● | ● | ● |
| AGD6030-MR | 6.0 | 3.0 | 26.0 | 5.0 | 5.8 | ● | ● | ● | ● |
| AGD8040-MR | 8.0 | 4.0 | 31.0 | 6.0 | 6.5 | ● | ● | ● | ● |

● Stok Stock ○ Talep Edilmesi Halinde Üretilenler Available upon order

| ISO | İş Parçası Malzemesi Workpiece Material | Sertlik Hardness (HB) | Kesme Hızı / Cutting Speed Vc m/min | | | | | | |
|-----|---|-----------------------------|-------------------------------------|-----------------|-----------------|----------------|----------------|-----------------|---------------|
| | | | AP1105 | AP1225 | AK1115 | AS3115 | AS3125 | AA4230 | AS9125 |
| P | Düşük Karbonlu Çelik Low Carbon Steel | 80 - 170 | 120 (80-220) | 120 (80-220) | | 70 (50-100) | 70 (50-100) | 110 (70-180) | |
| | Yüksek Karbonlu Çelik High Carbon Steel | 170 - 250 | 120 (80-220) | 120 (80-220) | | | | 110 (70-150) | |
| | Düşük Alaşımli Çelik Low-alloy Steel | 140 - 260 | 110 (60-180) | 110 (60-180) | | 70 (50-100) | 70 (50-100) | 110 (40-150) | |
| | Yüksek Alaşımli Çelik High-alloy Steel | 180 - 300 | 110 (60-180) | 110 (60-180) | | | | 110 (40-150) | |
| | Dökme Çelik Cast Steel | 180 - 300 | 110 (60-180) | 110 (60-180) | | | | 110 (40-150) | |
| M | Feritik / Martenzitik Ferritic / Martensitic | 150 - 270 | | | | 90 (50-150) | 90 (30-180) | 110 (40-180) | |
| | Östenitik Austenitic | 150 - 270 | | | | 90 (50-150) | 90 (30-180) | 110 (40-180) | |
| K | Dövülebilir Dökme Demir Malleable Cast Iron | 150 - 230 | | | 130 (50-200) | | | 110 (50-180) | |
| | Gri Dökme Demir Gray Cast Iron | 150 - 230 | | | 130 (50-200) | | | 110 (50-180) | |
| | Sferö Döküm Demir Nodular Cast Iron | 160 - 260 | | | 100 (50-150) | | | 100 (50-150) | |
| S | Isıya Dayanıklı Alaşımlar Heat-resistant Alloy | 130 - 400 | | | | 35 (15-60) | 35 (15-70) | | |
| | Titanyum Alaşımlar Titanium Alloys | 130 - 400 | | | | 35 (15-60) | 35 (15-70) | | 35 (15-60) |

Dış Çap Kanal Açma Takımları / External Grooving Toolholders



AKKO (AGD) / KRLY - JD (MGM) UCUNA UYGUNDUR
COMPATIBLE WITH AKKO (AGD) / KRLY - JD (MGM.) INSERT

ADKT-K-R/L-1212-1.5-T15
ADKT-K-R/L-2020-1.5-T15
ADKT-K-R/L-1212-2-T15
ADKT-K-R/L-1616-2-T10
ADKT-K-R/L-1616-2-T15
ADKT-K-R/L-2020-2-T15
ADKT-K-R/L-2525-2-T15
ADKT-K-R/L-3232-2-T15
ADKT-K-R/L-1212-3-T15

ADKT-K-R/L-1616-3-T15
ADKT-K-R/L-2020-3-T20
ADKT-K-R/L-2020-3-R28
ADKT-K-R/L-2525-3-R15
ADKT-K-R/L-2525-3-T22
ADKT-K-R/L-3232-3-T22
ADKT-K-R/L-2020-4-T20
ADKT-K-R/L-2020-4-R25
ADKT-K-R/L-2525-4-T18

ADKT-K-R/L-2525-4-T22
ADKT-K-R/L-3232-4-T22
ADKT-K-R/L-2020-5-T20
ADKT-K-R/L-2525-5-T18
ADKT-K-R/L-2525-5-T25
ADKT-K-R/L-3232-5-T25
ADKT-K-R/L-2525-6-T25
ADKT-K-R/L-3232-6-T25
ADKT-K-R/L-3232-8-T32



KRLY (KG.) UCUNA UYGUNDUR
COMPATIBLE WITH KRLY (KG.) INSERT

ADKT-KG-R/L-2020-2-T15
ADKT-KG-R/L-2525-2-T8
ADKT-KG-R/L-2525-2-T15
ADKT-KG-R/L-2525-2-T17
ADKT-KG-R/L-1616-3-T20
ADKT-KG-R/L-2020-3-T20
ADKT-KG-R/L-2525-3-T10
ADKT-KG-R/L-2525-3-T13
ADKT-KG-R/L-2525-3-T22

ADKT-KG-R/L-2020-4-T20
ADKT-KG-R/L-2525-4-T10
ADKT-KG-R/L-2525-4-T16
ADKT-KG-R/L-2525-4-T22
ADKT-KG-R/L-2525-5-T12
ADKT-KG-R/L-2525-5-T15
ADKT-KG-R/L-2525-5-T25
ADKT-KG-R/L-2525-6-T25



HRN (S229) UCUNA UYGUNDUR
COMPATIBLE WITH HRN (S229) INSERT

ADKT-H-R/L-2020-3-T20
ADKT-H-R/L-2525-3-T22
ADKT-H-R/L-2525-3-T26
ADKT-H-R/L-2020-4-T20
ADKT-H-R/L-2525-4-T22
ADKT-H-R/L-3232-4-T22
ADKT-H-R/L-2020-5-T20
ADKT-H-R/L-2525-5-T25
ADKT-H-R/L-2525-6-T25



HRN (S224-S223) UCUNA UYGUNDUR
COMPATIBLE WITH HRN (S224-S223) INSERT

ADKT-HK-R/L-1616-2-T15
ADKT-HK-R/L-2020-2-T15
ADKT-HK-R/L-2525-2-T15
ADKT-HK-R/L-2020-3-T20
ADKT-HK-R/L-2525-3-T22
ADKT-HK-R/L-2020-4-T20
ADKT-HK-R/L-2525-4-T22
ADKT-HS223-R/L-2020-2-T15
ADKT-HS223-R/L-2020-3-T17



ZCC (ZQMX) UCUNA UYGUNDUR
COMPATIBLE WITH ZCC (ZQMX) INSERT

ADKT-ZCC1-R/L-2020-3-T20
ADKT-ZCC1-R/L-2525-3-T22
ADKT-ZCC1-R/L-2020-4-T20
ADKT-ZCC1-R/L-2525-4-T22



ZCC (Z.D) UCUNA UYGUNDUR
COMPATIBLE WITH ZCC (Z.D) INSERT

ADKT-ZCC2-R/L-1616-2-T15
ADKT-ZCC2-R/L-2020-2-T7
ADKT-ZCC2-R/L-2020-2-T15
ADKT-ZCC2-R/L-2525-2-T15
ADKT-ZCC2-R/L-1616-2.5-T15
ADKT-ZCC2-R/L-2020-2.5-T17
ADKT-ZCC2-R/L-2525-2.5-T15
ADKT-ZCC2-R/L-1616-3-T15
ADKT-ZCC2-R/L-1616-3-T17
ADKT-ZCC2-R/L-1616-3-T20

ADKT-ZCC2-R/L-2020-3-T12
ADKT-ZCC2-R/L-2020-3-T20
ADKT-ZCC2-R/L-2020-3-R21
ADKT-ZCC2-R/L-2020-3-R25
ADKT-ZCC2-R/L-2525-3-T12
ADKT-ZCC2-R/L-2525-3-T22
ADKT-ZCC2-R/L-2525-3-R30
ADKT-ZCC2-R/L-2020-4-T12
ADKT-ZCC2-R/L-2020-4-T20
ADKT-ZCC2-R/L-2525-4-T12

ADKT-ZCC2-R/L-2525-4-T22
ADKT-ZCC2-R/L-2020-5-T12
ADKT-ZCC2-R/L-2020-5-T20
ADKT-ZCC2-R/L-2525-5-T12
ADKT-ZCC2-R/L-2525-5-T25
ADKT-ZCC2-R/L-3232-5-T25
ADKT-ZCC2-R/L-2020-6-T20
ADKT-ZCC2-R/L-2525-6-T25
ADKT-ZCC2-R/L-3232-6-T25
ADKT-ZCC2-R/L-3232-6-T30



KNMTL (A4.) UCUNA UYGUNDUR
COMPATIBLE WITH KNMTL (A4.) INSERT

ADKT-KM-R/L-2020-2-T15
ADKT-KM-R/L-2525-2-T15
ADKT-KM-R/L-2020-3-T20
ADKT-KM-R/L-2525-3-T22
ADKT-KM-R/L-2525-4-T22



ISCR (DGN-GRP-GIM-GIP-GTN-DCE) UCUNA UYGUNDUR
COMPATIBLE WITH ISCR (DGN-GRP-GIM-GIP-GTN-DCE) INSERT

ADKT-I-R/L-1212-2-T15
ADKT-I-R/L-1616-2-T15
ADKT-I-R/L-2020-2-T15
ADKT-I-R/L-2525-2-T15
ADKT-I-R/L-3232-2-T15
ADKT-I-R/L-1212-3-T15
ADKT-I-R/L-1616-3-T15
ADKT-I-R/L-2020-3-T12
ADKT-I-R/L-2020-3-T20
ADKT-I-R/L-2525-3-T12
ADKT-I-R/L-2525-3-T22
ADKT-I-R/L-3232-3-T22

ADKT-I-R/L-2020-4-T20
ADKT-I-R/L-2525-4-T12
ADKT-I-R/L-2525-4-T22
ADKT-I-R/L-3232-4-T25
ADKT-I-R/L-2020-5-T20
ADKT-I-R/L-2525-5-T12
ADKT-I-R/L-2525-5-T25
ADKT-IG-R/L-1616-3-T18
ADKT-IG-R/L-2020-3-T12
ADKT-IG-R/L-2020-3-R20
ADKT-IG-R/L-2525-3-T12
ADKT-IG-R/L-2525-3-T22

ADKT-IGI-R/L-2020-2-T15
ADKT-IGI-R/L-2525-2-T15
ADKT-IGI-R/L-1616-3-T15
ADKT-IGI-R/L-2020-3-T20
ADKT-IGI-R/L-2525-3-T9
ADKT-IGI-R/L-2525-3-T22
ADKT-IGI-R/L-2525-4-T22
ADKT-IGI-R/L-2525-5-T25
ADKT-IGI-R/L-2525-8-T30
ADKT-IGTN-R/L-2525-5-T25
ADKT-IDC-R/L-2525-3-T21



ITG (TGM.) UCUNA UYGUNDUR
COMPATIBLE WITH ITG (TGM.) INSERT

ADKT-ITG-R/L-2020-3-T8
ADKT-ITG-R/L-2525-3-T8
ADKT-ITG-R/L-3232-3-T8
ADKT-ITG-R/L-2020-4-T9
ADKT-ITG-R/L-2525-4-T17
ADKT-ITG-R/L-3232-4-T17
ADKT-ITG-R/L-3232-5-T25

Kanal Açma Takımları / Grooving Toolholders



ADKT-123-R/L-1212-1.5-R15
ADKT-123-R/L-1616-1.5-R15
ADKT-123-R/L-1616-2-T15
ADKT-123-R/L-2020-2-T8
ADKT-123-R/L-2020-2-T15
ADKT-123-R/L-2525-2-T8
ADKT-123-R/L-2525-2-T15
ADKT-123-R/L-3232-2-T15
ADKT-123-R/L-1616-3-T10
ADKT-123-R/L-1616-3-T15
ADKT-123-R-2020-3-T10
ADKT-123-R-2020-3-T15

ADKT-123-R/L-2020-3-T20
ADKT-123-R-2525-3-T10
ADKT-123-R-2525-3-T15
ADKT-123-R/L-2525-3-T22
ADKT-123-R/L-2020-4-T20
ADKT-123-R-2525-4-T13
ADKT-123-R/L-2525-4-T22
ADKT-123-R/L-3232-4-T25
ADKT-123-R/L-2020-5-T20
ADKT-123-R/L-2525-5-T25
ADKT-123-R/L-3232-6-T15

**SNDVK (123) UCUNA UYGUNDUR
COMPATIBLE WITH SNDVK (123) INSERT**



ADKT-151.22-R/L-1616-2-T15
ADKT-151.22-R/L-2020-2-T15
ADKT-151.22-R/L-2525-2-T15
ADKT-151.22-R/L-1616-3-T15
ADKT-151.22-R/L-2020-3-T20
ADKT-151.22-R/L-2525-3-T22
ADKT-151.22-R/L-1616-4-T15
ADKT-151.22-R/L-2020-4-T20
ADKT-151.22-R/L-2525-4-T22
ADKT-151.22-R/L-2020-5-T20
ADKT-151.22-R/L-2525-5-T25

**SNDVK (151.2) UCUNA UYGUNDUR
COMPATIBLE WITH SNDVK (151.2) INSERT**



ADKT-151.23-R/L-1616-2-T15
ADKT-151.23-R/L-2020-2-T15
ADKT-151.23-R/L-2525-2-T15
ADKT-151.23-R/L-1616-2.5-T15
ADKT-151.23-R/L-2020-2.5-T15
ADKT-151.23-R/L-2525-2.5-T15
ADKT-151.23-R/L-1212-3-T15
ADKT-151.23-R/L-1616-3-T15

ADKT-151.23-R/L-2020-3-T20
ADKT-151.23-R/L-2525-3-T20
ADKT-151.23-R/L-2525-3-T22
ADKT-151.23-R/L-1616-4-T15
ADKT-151.23-R/L-2020-4-T20
ADKT-151.23-R/L-2525-4-T22
ADKT-151.23-R/L-2020-5-T20
ADKT-151.23-R/L-2525-5-T25

**SNDVK (151.2) UCUNA UYGUNDUR
COMPATIBLE WITH SNDVK (151.2) INSERT**



ADKT-154.91-R/L-2020-3-T4
ADKT-154.91-R/L-2525-3-T4
ADKT-154.91-R/L-2020-5-T5
ADKT-154.91-R/L-2525-5-T5

**SNDVK (154.91) UCUNA UYGUNDUR
COMPATIBLE WITH SNDVK (154.91) INSERT**



ADKT-ARN-R/L-2020-2-T15
ADKT-ARN-R/L-2525-2-T15
ADKT-ARN-R/L-2020-3-T20
ADKT-ARN-R/L-2525-3-T22

**ARN (LOMR) UCUNA UYGUNDUR
COMPATIBLE WITH ARN (LOMR) INSERT**



ADKT-TD-R/L-1212-2-T15
ADKT-TD-R/L-1616-2-T8
ADKT-TD-R/L-1616-2-T15
ADKT-TD-R/L-2020-2-T9
ADKT-TD-R/L-2020-2-T15
ADKT-TD-R/L-2020-2-T17
ADKT-TD-R/L-2020-2-T20
ADKT-TD-R/L-2525-2-T8
ADKT-TD-R/L-2525-2-T17

**TGTC (TD.) UCUNA UYGUNDUR
COMPATIBLE WITH TGTC (TD.) INSERT**

ADKT-TD-R/L-1212-3-T15
ADKT-TD-R/L-1616-3-T15
ADKT-TD-R/L-2020-3-T12
ADKT-TD-R/L-2020-3-T20
ADKT-TD-R/L-2020-3-T25
ADKT-TD-R/L-2020-3-T30
ADKT-TD-R/L-2525-3-T9
ADKT-TD-R/L-2525-3-T12
ADKT-TD-R/L-2525-3-T22
ADKT-TD-R/L-2525-3-T25
ADKT-TD-R/L-2525-3-T30
ADKT-TD-R/L-3232-3-T25
ADKT-TD-R/L-2525-4-T10
ADKT-TD-R/L-2525-4-T15
ADKT-TD-R/L-2525-4-T22
ADKT-TD-R/L-2525-4-T25
ADKT-TD-R/L-2525-4-T30
ADKT-TD-R/L-2525-5-T25



ADKT-RD-R/L-1616-2-T17
ADKT-RD-R/L-2020-2-T17
ADKT-RD-R/L-2525-2-T17
ADKT-RD-R/L-1616-3-T20
ADKT-RD-R/L-2020-3-T25
ADKT-RD-R/L-2525-3-T25
ADKT-RD-R/L-2020-4-T30
ADKT-RD-R/L-2525-4-T30

**TGTC (RD.) UCUNA UYGUNDUR
COMPATIBLE WITH TGTC (RD.) INSERT**



ADKT-SWC-R/L-2020-2-T25
ADKT-SWC-R/L-2020-3-T25

**SMTM (WCF) UCUNA UYGUNDUR
COMPATIBLE WITH SMTM (WCF) INSERT**



ADKT-TG-R/L-1616-2-R17
ADKT-TG-R/L-2020-2-T8
ADKT-TG-R/L-2020-2-R12
ADKT-TG-R/L-2020-2-R17
ADKT-TG-R/L-2525-2-R12
ADKT-TG-R/L-2525-2-R17
ADKT-TG-R/L-1616-3-T20
ADKT-TG-R/L-2020-3-T12
ADKT-TG-R/L-2020-3-T20
ADKT-TG-R/L-2525-3-T9
ADKT-TG-R/L-2525-3-T20
ADKT-TG-R/L-2525-3-R25
ADKT-TG-R/L-2525-4-T15
ADKT-TG-R/L-2525-4-T20
ADKT-TG-R/L-2525-4-T25
ADKT-TG-R/L-2525-5-T12
ADKT-TG-R/L-2525-5-T25
ADKT-TG-R/L-2525-5-T32

**TNGLY (DGM) UCUNA UYGUNDUR
COMPATIBLE WITH TNGLY (DGM) INSERT**



ADKT-SGC-R/L-1212-2-R15
ADKT-SGC-R/L-1616-2-R15
ADKT-SGC-R/L-2020-2-R20
ADKT-SGC-R/L-2525-2-R20
ADKT-SGC-R/L-1212-3-R15
ADKT-SGC-R/L-1616-3-R15
ADKT-SGC-R/L-2020-3-R22
ADKT-SGC-R/L-2525-3-R15
ADKT-SGC-R/L-2525-3-R22
ADKT-SGC-R/L-2525-4-R25

**SMTM (GCM) UCUNA UYGUNDUR
COMPATIBLE WITH SMTM (GCM) INSERT**



ADKT-H22-R/L-1616-(0.5-2)-T6
ADKT-H22-R/L-2020-(0.5-2)-T6
ADKT-H22-R/L-2525-(0.5-2)-T6

**HRN (S312) UCUNA UYGUNDUR
COMPATIBLE WITH HRN (S312) INSERT**



ADKT-WGX16-R/L-2020-2-R16
ADKT-WGX16-R/L-2525-2-R16
ADKT-WGX24-R/L-2020-3-T20
ADKT-WGX24-R/L-2525-3-T22
ADKT-WGX24-R/L-3232-3-T22
ADKT-WGX24-R/L-2525-4-T22
ADKT-WGX24-R/L-2525-5-T25
ADKT-WGX24-R/L-3232-5-T25

**WLTR (GX16-GX24) UCUNA UYGUNDUR
COMPATIBLE WITH WLTR (GX16-GX24) INSERT**



ADKT-GP-R/L-2020-2-T15
ADKT-GP-R/L-2525-2-T15
ADKT-GP-R/L-2020-3-T20
ADKT-GP-R/L-2525-3-T22
ADKT-GP-R/L-2525-4-T22
ADKT-GP-R/L-2525-5-T25

**PLBT (GP) UCUNA UYGUNDUR
COMPATIBLE WITH PLBT (GP) INSERT**



ADKT-CD-R/L-2020-3-R20
ADKT-CD-R/L-2525-3-R23

**CRZTZ (GX24.) UCUNA UYGUNDUR
COMPATIBLE WITH CRZTZ (GX24.) INSERT**



ADKT-LGC-R/L-1616-2-D40
ADKT-LGC-R/L-2020-2-D40
ADKT-LGC-R/L-2525-2-D40
ADKT-LGC-R/L-1616-3-T20
ADKT-LGC-R/L-2020-3-T20
ADKT-LGC-R/L-2525-3-T20

**LMNA (GCTX) UCUNA UYGUNDUR
COMPATIBLE WITH LMNA (GCTX) INSERT**

Dış Çap Kanal Açma İsviçre Tipi Kayar Otomat Takımları External Grooving Toolholders For Swiss Type Sliding Automatic Lathes



ADKT-TD-R/L-1212-2-T12-K-S
ADKT-TD-R/L-1616-2-T16-K-S
ADKT-R/L-1212-3-T12-K-S
ADKT-TD-R/L-1616-3-T16-K-S

TGTC (TD.) UCUNA UYGUNDUR
COMPATIBLE WITH TGTC (TD.) INSERT



ADKT-K-R/L-1212-2-R12-K-S
ADKT-K-R/L-1616-2-R16-K-S
ADKT-K-R/L-1212-3-R12-K-S
ADKT-K-R/L-1616-3-R16-K-S

AKKO (AGD) / KRLY - JD (MGM.) UCUNA UYGUNDUR
COMPATIBLE WITH AKKO (AGD) / KRLY - JD (MGM.) INSERT



ADKT-ZCC2-R/L-1010-2-T12-K-S
ADKT-ZCC2-R/L-1212-2-T12-K-S
ADKT-ZCC2-R/L-1616-2-R16-K-S
ADKT-ZCC2-R/L-1212-3-T12-K-S

ZCC (Z..D) UCUNA UYGUNDUR
COMPATIBLE WITH ZCC (Z..D) INSERT



ADKT-KG-R/L-1212-2-R12-K-S
ADKT-KG-R/L-1616-2-R16-K-S
ADKT-KG-R/L-1212-3-R12-K-S
ADKT-KG-R/L-1616-3-R16-K-S

KRLY (KG.) UCUNA UYGUNDUR
COMPATIBLE WITH KRLY (KG.) INSERT



ADKT-I-R/L-0808-2-R10-S
ADKT-I-R/L-1010-2-R10-K-S
ADKT-I-R/L-1212-2-R12-K-S
ADKT-I-R/L-1616-3-R16-K-S

ISCR (DGN) UCUNA UYGUNDUR
COMPATIBLE WITH ISCR (DGN) INSERT



ADKT-WGX16-R/L-1212-2-R12-K-S
ADKT-WGX16-R/L-1616-2-R16-K-S
ADKT-WGX24-R/L-1616-3-R16-K-S

WLTR (GX16-GX24) UCUNA UYGUNDUR
COMPATIBLE WITH WLTR (GX16-GX24) INSERT



ADKT-RD-R/L-1212-2-T12-K-S
ADKT-RD-R/L-1616-2-T17-K-S
ADKT-RD-R/L-1212-3-T12-K-S

TGTC (RD.) UCUNA UYGUNDUR
COMPATIBLE WITH TGTC (RD.) INSERT



ADKT-TG-R/L-1212-2-R12-K-S
ADKT-TG-R/L-1212-3-R12-K-S

TNGLY (DGM) UCUNA UYGUNDUR
COMPATIBLE WITH TNGLY (DGM) INSERT



ADKT-K-R/L-2020-3-T20-H
ADKT-K-R/L-2525-3-T22-H
ADKT-K-R/L-2020-4-T20-H
ADKT-K-R/L-2525-4-T22-H
ADKT-K-R/L-2525-5-T25-H

AKKO (AGD) / KRLY - JD (MGM.) UCUNA UYGUNDUR
COMPATIBLE WITH AKKO (AGD) / KRLY - JD (MGM.) INSERT



ADKT-TD-R/L-2020-3-T30-H

TGTC (TD.) UCUNA UYGUNDUR
COMPATIBLE WITH TGTC (TD.) INSERT

Dış Çap Alın Kanal Açma Takımları / Face Grooving Toolholders



AAKT-K-R/L-2525-34-45-3-T17
AAKT-K-R/L-2525-39-55-3-T17
AAKT-K-R/L-2525-49-80-3-T17
AAKT-K-R/L-2525-70-110-3-T17
AAKT-K-R/L-2525-100-150-3-T17
AAKT-K-R/L-2525-80-180-3-T32
AAKT-K-R/L-2525-175-215-3-T22
AAKT-K-R/L-2525-700-800-3-T17
AAKT-K-R/L-2525-50-85-4-T22

AKKO (AGD) / KRLY - JD (MGM.) UCUNA UYGUNDUR
COMPATIBLE WITH AKKO (AGD) / KRLY - JD (MGM.) INSERT

AAKT-K-R/L-2525-70-110-4-T22
AAKT-K-R/L-2525-100-150-4-T22
AAKT-K-R/L-2525-80-180-4-T32
AAKT-K-R/L-2525-180-800-4-T32
AAKT-K-R/L-2525-70-110-5-T25
AAKT-K-R/L-2525-100-150-5-T25
AAKT-K-R/L-2525-80-180-5-T32
AAKT-K-R/L-2525-140-200-5-T25
AAKT-K-R/L-2525-180-800-5-T32

AAKT-K-R/L-2525-60-100-6-T25
AAKT-K-R/L-2525-60-100-6-T35
AAKT-K-R/L-2525-100-200-6-T25
AAKT-K-R/L-2525-100-200-6-T35
AAKT-K-R/L-2525-100-200-6-T45
AAKT-K-R/L-2525-140-300-6-T35
AAKT-K-R/L-2525-140-300-8-T35
AAKT-K-R/L-3232-140-350-8-T35



AAKT-ZCC2-R/L-2525-140-180-2-T4
AAKT-ZCC2-R/L-2525-35-45-3-T17
AAKT-ZCC2-R/L-2525-39-55-3-T17
AAKT-ZCC2-R/L-2525-49-80-3-T17
AAKT-ZCC2-R/L-2525-70-110-3-T15
AAKT-ZCC2-R/L-2525-70-110-3-T17
AAKT-ZCC2-R/L-2525-100-150-3-T17

ZCC (Z..D) UCUNA UYGUNDUR
COMPATIBLE WITH ZCC (Z..D) INSERT

AAKT-ZCC2-R/L-2525-40-60-4-T22
AAKT-ZCC2-R/L-2525-52-80-4-T22
AAKT-ZCC2-R/L-2525-72-110-4-T22
AAKT-ZCC2-R/L-2525-100-150-4-T22
AAKT-ZCC2-R/L-2525-140-200-4-T22
AAKT-ZCC2-R/L-2525-55-95-5-T25
AAKT-ZCC2-R/L-2525-85-140-5-T25

AAKT-ZCC2-R/L-2525-130-200-5-T25
AAKT-ZCC2-R/L-2525-190-400-5-T25
AAKT-ZCC2-R/L-2525-190-400-5-T35
AAKT-ZCC2-R/L-2525-200-500-5-T17
AAKT-ZCC2-R/L-2525-60-110-6-T15



AAKT-KG-R/L-2525-44-70-4-T22
AAKT-KG-R/L-2525-60-120-4-T22
AAKT-KG-R/L-2525-112-200-4-T22

KRLY - JD (KG.) UCUNA UYGUNDUR
COMPATIBLE WITH KRLY - JD (KG.) INSERT

Kanal Açma Takımları / Grooving Toolholders



AAKT-IG-R/L-2525-40-60-4-T25
 AAKT-IG-R/L-2525-52-80-4-T25
 AAKT-IG-R/L-2525-70-110-4-T28
 AAKT-IG-R/L-2525-100-150-4-T25
 AAKT-IG-R/L-2525-110-200-4-T28
 AAKT-IG-R/L-2525-110-200-4-T32
 AAKT-IG-R/L-2525-180-800-4-T28
 AAKT-IG-R/L-2525-70-110-5-T32
 AAKT-IG-R/L-2525-110-200-5-T9
 AAKT-IG-R/L-2525-110-200-5-T32
 AAKT-IG-R/L-2525-180-800-5-T32
 AAKT-IG-R/L-2525-58-100-6-T32
 AAKT-IG-R/L-2525-88-180-6-T32

ISCR (DGN-GRP) UCUNA UYGUNDUR
 COMPATIBLE WITH ISCR (DGN-GRP) INSERT

L Tip Alın Kanal Açma Takımları / L Type Face External Grooving Toolholders



ALKT-ZCC2-R/L-2525-35-45-3-T10
 ALKT-ZCC2-R/L-2525-39-55-3-T10
 ALKT-ZCC2-R/L-2525-35- \varnothing -3-T4
 ALKT-ZCC2-R/L-2525-40-60-4-T14
 ALKT-ZCC2-R/L-2525-52-80-4-T14
 ALKT-ZCC2-R/L-2525-72-110-4-T14
 ALKT-ZCC2-R/L-2525-100-230-4-T14
 ALKT-ZCC2-R/L-2525-40- \varnothing -4-T4

ZCC (Z.D) UCUNA UYGUNDUR
 COMPATIBLE WITH ZCC (Z.D) INSERT

Kesme ve Derin Kanal Açma Lamaları Blades For Parting and Deep Grooving



AKL-I-26-2
 AKL-I-32-2
 AKL-I-26-3
 AKL-I-32-3
 AKL-I-26-4
 AKL-I-32-4

ISCR (DGN-GRP) UCUNA UYGUNDUR
 COMPATIBLE WITH ISCR (DGN-GRP) INSERT



AKL-123-32-2
 AKL-123-32-3
 AKL-123-32-4

SNDVK (123) UCUNA UYGUNDUR
 COMPATIBLE WITH SNDVK (123) INSERT



AKL-TD-32-2
 AKL-TD-32-3

TGTC (TD.) UCUNA UYGUNDUR
 COMPATIBLE WITH TGTC (TD.) INSERT



AKL-SGC-26-3
 AKL-SGC-32-3

SMTM (GCM) UCUNA UYGUNDUR
 COMPATIBLE WITH SMTM (GCM) INSERT



AKL-K-32-2
 AKL-K-32-3
 AKL-K-32-4

KRLY (MGM.) UCUNA UYGUNDUR
 COMPATIBLE WITH KRLY (MGM.) INSERT

Kesme ve Derin Kanal Açma Lama Bloğu Blocks For Parting and Deep Grooving Blades



ALBU-20-26
 ALBU-20-32
 ALBU-25-26
 ALBU-25-32
 ALBU-32-32

ALBU

Mini Kanal Kateri / Mini Grooving Tool



AIKT-MB07-A16-090-15
 AIKT-MB07-A16-090-22
 AIKT-MB09-A16-090-19
 AIKT-MB09-A16-110-40
 AIKT-MB09-A16-095-28

SNDVK (MB) UCUNA UYGUNDUR
 COMPATIBLE WITH SNDVK (MB) INSERT



AIKT-K-R/L-16-2-T4
 AIKT-K-R/L-20-2-T4
 AIKT-K-R/L-25-2-T6
 AIKT-K-R/L-20-3-T6
 AIKT-K-R/L-20-3-T7
 AIKT-K-R/L-25-3-T6
 AIKT-K-R/L-25-3-T10
 AIKT-K-R/L-32-3-T6

AKKO (AGD) / KRLY - JD (MGM.) UCUNA UYGUNDUR
 COMPATIBLE WITH AKKO (AGD) / KRLY - JD (MGM.) INSERT

AIKT-K-R/L-32-3-T12
 AIKT-K-R/L-40-3-T6
 AIKT-K-R/L-40-3-T12
 AIKT-K-R/L-20-4-T6
 AIKT-K-R/L-20-4-T7
 AIKT-K-R/L-25-4-T6
 AIKT-K-R/L-25-4-T10
 AIKT-K-R/L-32-4-T6

AIKT-K-R/L-32-4-T12
 AIKT-K-R/L-40-4-T6
 AIKT-K-R/L-40-4-T12
 AIKT-K-R/L-25-5-T7
 AIKT-K-R/L-32-5-T7
 AIKT-K-R/L-40-5-T7
 AIKT-K-R/L-40-5-T12



AIKT-KG-R/L-25-2-T7
 AIKT-KG-R/L-20-3-T6.5-H
 AIKT-KG-R/L-25-3-T7
 AIKT-KG-R/L-40-3-T8
 AIKT-KG-R/L-25-4-T8

KRLY (KG.) UCUNA UYGUNDUR
 COMPATIBLE WITH KRLY (KG.) INSERT



AIKT-RD-R/L-16-2-T6
 AIKT-RD-R/L-20-2-T6
 AIKT-RD-R/L-25-2-T6
 AIKT-RD-R/L-16-3-T6
 AIKT-RD-R/L-20-3-T6
 AIKT-RD-R/L-25-3-T6
 AIKT-RD-R/L-32-3-T6
 AIKT-RD-R/L-20-4-T6
 AIKT-RD-R/L-25-4-T6
 AIKT-RD-R/L-32-4-T6

TGTC (RD.) UCUNA UYGUNDUR
 COMPATIBLE WITH TGTC (RD.) INSERT



AIKT-TG-R/L-20-2-T6
 AIKT-TG-R/L-20-3-T6
 AIKT-TG-R/L-25-3-T8
 AIKT-TG-R/L-32-3-T10
 AIKT-TG-R/L-32-3-T12
 AIKT-TG-R/L-32-4-T10
 AIKT-TG-R/L-32-5-T10

TNGLY (DGM) UCUNA UYGUNDUR
 COMPATIBLE WITH TNGLY (DGM) INSERT



AIKT-H-R/L-25-3-T8
AIKT-H-R/L-32-3-T7
AIKT-H-R/L-40-3-T7
AIKT-H-R/L-25-4-T8

AIKT-H-R/L-32-4-T7
AIKT-H-R/L-40-4-T7
AIKT-H-R/L-25-5-T8
AIKT-H-R/L-32-5-T7
AIKT-H-R/L-40-5-T7

HRN (S229) UCUNA UYGUNDUR
COMPATIBLE WITH HRN (S229) INSERT



AIKT-154.91-R/L-16-3-T3
AIKT-154.91-R/L-20-3-T4
AIKT-154.91-R/L-25-3-T4
AIKT-154.91-R/L-25-5-T5
AIKT-154.91-R/L-32-5-T5

SNDVK (154.91) UCUNA UYGUNDUR
COMPATIBLE WITH SNDVK (154.91) INSERT



AIKT-123-R/L-20-2-T6
AIKT-123-R/L-25-2-T6
AIKT-123-R/L-32-2-T7
AIKT-123-R/L-20-3-T6
AIKT-123-R/L-25-3-T7
AIKT-123-R/L-32-3-T9

AIKT-123-R/L-20-4-T8
AIKT-123-R/L-25-4-T7
AIKT-123-R/L-32-4-T7
AIKT-123-R/L-32-4-T10
AIKT-123-R/L-25-5-T8
AIKT-123-R/L-32-5-T11

SNDVK (123) UCUNA UYGUNDUR
COMPATIBLE WITH SNDVK (123) INSERT



AIKT-HK-R/L-20-2-T6
AIKT-HK-R/L-25-2-T6
AIKT-HK-R/L-20-3-T6
AIKT-HK-R/L-25-3-T6
AIKT-HK-R/L-32-3-T6
AIKT-HK-R/L-20-4-T6
AIKT-HK-R/L-25-4-T6
AIKT-HK-R/L-32-4-T6

HRN (S224-S223) UCUNA UYGUNDUR
COMPATIBLE WITH HRN (S224-S223) INSERT



AIKT-ZCC2-R/L-16-2-T4
AIKT-ZCC2-R/L-20-3-T5
AIKT-ZCC2-R/L-20-3-T8
AIKT-ZCC2-R/L-25-3-T5
AIKT-ZCC2-R/L-25-3-T10
AIKT-ZCC2-R/L-32-3-T6
AIKT-ZCC2-R/L-32-3-T8
AIKT-ZCC2-R/L-32-3-T13
AIKT-ZCC2-R/L-40-3-T12

AIKT-ZCC2-R/L-25-4-T6
AIKT-ZCC2-R/L-32-4-T7
AIKT-ZCC2-R/L-32-4-T8
AIKT-ZCC2-R/L-32-4-T10
AIKT-ZCC2-R/L-32-5-T7
AIKT-ZCC2-R/L-32-5-T8
AIKT-ZCC2-R/L-40-5-T8
AIKT-ZCC2-R/L-40-5-T10

ZCC (Z.D) UCUNA UYGUNDUR
COMPATIBLE WITH ZCC (Z.D) INSERT



AIKT-ITG-R/L-16-3-T6-H
AIKT-ITG-R/L-20-3-T6-H
AIKT-ITG-R/L-25-3-T8-H
AIKT-ITG-R/L-32-3-T8-H
AIKT-ITG-R/L-20-4-T6-H
AIKT-ITG-R/L-25-4-T7-H
AIKT-ITG-R/L-25-4-T9-H
AIKT-ITG-R/L-32-4-T11-H
AIKT-ITG-R/L-40-4-T11-H
AIKT-ITG-R/L-32-6.35-T17.5-H

ISCR (TGM.) UCUNA UYGUNDUR
COMPATIBLE WITH ISCR (TGM.) INSERT



AIKT-I-R/L-20-3-T5
AIKT-I-R/L-25-3-T6

ISCR (DGN) UCUNA UYGUNDUR
COMPATIBLE WITH ISCR (DGN) INSERT



AIKT-IG-R/L-25-4-T10-H
AIKT-IG-R/L-32-4-T10-H
AIKT-IG-R/L-40-4-T12-H
AIKT-IG-R/L-25-5-T10-H
AIKT-IG-R/L-32-5-T10-H
AIKT-IG-R/L-40-5-T12-H
AIKT-IG-R/L-50-5-T12-H

ISCR (DGN-GRP) UCUNA UYGUNDUR
COMPATIBLE WITH ISCR (DGN-GRP) INSERT



AIKT-IGI-R/L-20-3-T4
AIKT-IGI-R/L-25-3-T5
AIKT-IGI-R/L-32-3-T5
AIKT-IGI-R/L-40-3-T5
AIKT-IGI-R/L-20-4-T4
AIKT-IGI-R/L-25-5-T10
AIKT-IGI-R/L-25-5-T15

ISCR (GIMIY-GIPI) UCUNA UYGUNDUR
COMPATIBLE WITH ISCR (GIMIY-GIPI) INSERT



AIKT-IGE-R/L-10-2-T3-H
AIKT-IGE-R/L-16-2-T3-D11.5
AIKT-IGE-R/L-16-2-T2.5-H
AIKT-IGE-R/L-16-3-T2.5-H
AIKT-IGE-R/L-16-3-T2.5-D20

ISCR (GEPI) UCUNA UYGUNDUR
COMPATIBLE WITH ISCR (GEPI) INSERT



AIKT-SGC-R-25-3-T6
AIKT-SGC-R-32-3-T6
AIKT-SGC-R-40-3-T6

SMTM (GCM) UCUNA UYGUNDUR
COMPATIBLE WITH SMTM (GCM) INSERT



AIKT-QC11-R/L-20-(0.5-1.8)
AIKT-QC16-R/L-20-(0.5-2.5)
AIKT-QC22-R/L-25-(2.5-3.3)
AIKT-QC22-R/L-25-(3.3-4.8)

ZCC (QC..) UCUNA UYGUNDUR
COMPATIBLE WITH ZCC (QC..) INSERT



AIKT-KM-R/L-20-2-T7
AIKT-KM-R/L-20-3-T7
AIKT-KM-R/L-25-3-T10
AIKT-KM-R/L-32-3-T12
AIKT-KM-R/L-40-3-T12
AIKT-KM-R/L-20-4-T7
AIKT-KM-R/L-32-4-T12.2-H

KNMTL (A4.) UCUNA UYGUNDUR
COMPATIBLE WITH KNMTL (A4.) INSERT



AIKT-GP-R/L-20-2-T4
AIKT-GP-R/L-25-2-T6
AIKT-GP-R/L-20-3-T6
AIKT-GP-R/L-25-3-T6
AIKT-GP-R/L-32-3-T6
AIKT-GP-R/L-20-4-T6
AIKT-GP-R/L-25-4-T6
AIKT-GP-R/L-32-4-T6

PLBT (GP) UCUNA UYGUNDUR
COMPATIBLE WITH PLBT (GP) INSERT



AIKT-TD-R-16-2-T8.5-H
AIKT-TD-R-20-3-T6-H
AIKT-TD-R-25-3-T6-H
AIKT-TD-R-32-3-T5-H

TGTC (TD.) UCUNA UYGUNDUR
COMPATIBLE WITH TGTC (TD.) INSERT

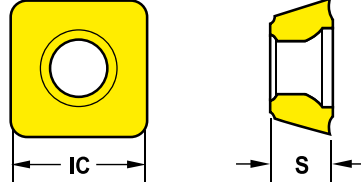
Delik Delme Uçları (SPMX - WCMX) / Drilling Inerts (SPMX - WCMX)

| | IC | S |
|--------|-------|-------|
| Metric | 5 | 2.38 |
| Inch | 0.197 | 0.094 |
| Metric | 6 | 2.41 |
| Inch | 0.236 | 0.094 |
| Metric | 7.94 | 3.97 |
| Inch | 0.313 | 0.156 |
| Metric | 9.8 | 4.3 |
| Inch | 0.386 | 0.169 |
| Metric | 11.5 | 4.8 |
| Inch | 0.453 | 0.189 |
| Metric | 14.3 | 5.2 |
| Inch | 0.563 | 0.205 |

**ISO 4 Corner / 4 Köşeli
SPMX Series / Serileri**
00, 01, 02, 03, 04, 05

| EDP | DESCRIPTION / AÇIKLAMA | FEED RATE / İLERLEME | |
|---------------|------------------------|----------------------|-----------|
| T.01.07.02.00 | SPMX050204-VG3002 | mm/rev. | 0.07~0.14 |
| | | Inch/rev. | .003~.006 |
| T.01.07.02.01 | SPMX060204-VG3002 | mm/rev. | 0.08~0.14 |
| | | Inch/rev. | .003~.006 |
| T.01.07.02.02 | SPMX07T308-VG3002 | mm/rev. | 0.08~0.16 |
| | | Inch/rev. | .003~.006 |
| T.01.07.02.03 | SPMX090408-VG3002 | mm/rev. | 0.08~0.16 |
| | | Inch/rev. | .003~.006 |
| T.01.07.02.04 | SPMX110408-VG3002 | mm/rev. | 0.10~0.18 |
| | | Inch/rev. | .004~.007 |
| T.01.07.02.05 | SPMX140512-VG3002 | mm/rev. | 0.10~0.20 |
| | | Inch/rev. | .004~.008 |

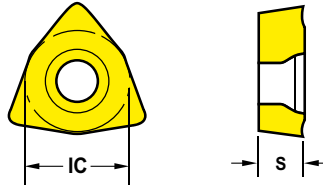

| | IC | S |
|--------|-------|-------|
| Metric | 5.56 | 2.38 |
| Inch | 0.219 | 0.094 |
| Metric | 6.35 | 2.38 |
| Inch | 0.236 | 0.094 |
| Metric | 7.94 | 3.18 |
| Inch | 0.313 | 0.125 |
| Metric | 9.53 | 3.97 |
| Inch | 0.375 | 0.156 |
| Metric | 12.7 | 4.76 |
| Inch | 0.500 | 0.187 |

**ISO 3 Corner / 3 Köşeli
WCMX Series / Serileri**
01, 02, 03, 04, 05

| EDP | DESCRIPTION / AÇIKLAMA | FEED RATE / İLERLEME | |
|---------------|------------------------|----------------------|-----------|
| T.01.07.01.01 | WCMX030208-VG3002 | mm/rev. | 0.05~0.12 |
| | | Inch/rev. | .002~.005 |
| T.01.07.01.02 | WCMX040208-VG3002 | mm/rev. | 0.05~0.12 |
| | | Inch/rev. | .002~.005 |
| T.01.07.01.03 | WCMX050308-VG3002 | mm/rev. | 0.06~0.14 |
| | | Inch/rev. | .002~.006 |
| T.01.07.01.04 | WCMX06T308-VG3002 | mm/rev. | 0.08~0.14 |
| | | Inch/rev. | .003~.006 |
| T.01.07.01.05 | WCMX080412-VG3002 | mm/rev. | 0.08~0.14 |
| | | Inch/rev. | .003~.006 |

| Cutting Speed / Kesme Hızı | | | Vc (ft/min) | |
|----------------------------|-------|--|-------------|------|
| ISO | VDI | Sub Group / Alt Grup | VG3002 | |
| | | | Min | Max |
| P | 1~5 | Non-Alloyed Steel / Alaşimsız Çelik | 460 | 1250 |
| | 6~9 | Low-Alloyed Steel / Düşük Alaşımli Çelik | 390 | 980 |
| | 10~11 | High-Alloyed Steel / Yüksek Alaşımli Çelik | 230 | 490 |
| M | 12~13 | Ferritic & Martensitic / Ferritik Ve Martenzitik | 390 | 660 |
| | 14 | Austenitic Stainless Steel / Östenitik Paslanmaz Çelik | 430 | 820 |
| K | 15~16 | Grey Cast Iron / Gri Dökme Demir | 390 | 820 |
| | 17~18 | Nodular Cast Iron / Sferö Döküm Demir | 430 | 720 |

Takma Uçlu Matkaplar / U-Drill System

D2 WCM - (ISO)



ATUM 16XD2 WCM. 030208
ATUM 16.5XD2 WCM. 030208
ATUM 17XD2 WCM. 030208
ATUM 17.5XD2 WCM. 030208
ATUM 18XD2 WCM. 030208
ATUM 18.5XD2 WCM. 030208
ATUM 19XD2 WCM. 030208
ATUM 19.5XD2 WCM. 030208
ATUM 20XD2 WCM. 040208
ATUM 20.5XD2 WCM. 040208
ATUM 21XD2 WCM. 040208
ATUM 21.5XD2 WCM. 040208
ATUM 22XD2 WCM. 040208
ATUM 22.5XD2 WCM. 040208
ATUM 23XD2 WCM. 040208
ATUM 23.5XD2 WCM. 040208
ATUM 24XD2 WCM. 050308
ATUM 24.5XD2 WCM. 050308
ATUM 25XD2 WCM. 050308
ATUM 25.5XD2 WCM. 050308
ATUM 26XD2 WCM. 050308
ATUM 26.5XD2 WCM. 050308
ATUM 27XD2 WCM. 050308
ATUM 27.5XD2 WCM. 050308
ATUM 28XD2 WCM. 050308
ATUM 28.5XD2 WCM. 050308
ATUM 29XD2 WCM. 050308
ATUM 29.5XD2 WCM. 050308
ATUM 30XD2 WCM. 06T308
ATUM 31XD2 WCM. 06T308
ATUM 32XD2 WCM. 06T308
ATUM 33XD2 WCM. 06T308
ATUM 34XD2 WCM. 06T308
ATUM 35XD2 WCM. 06T308
ATUM 36XD2 WCM. 06T308
ATUM 37XD2 WCM. 06T308
ATUM 38XD2 WCM. 06T308
ATUM 39XD2 WCM. 06T308
ATUM 40XD2 WCM. 06T308
ATUM 41XD2 WCM. 06T308
ATUM 42XD2 WCM. 06T308
ATUM 43XD2 WCM. 06T308
ATUM 44XD2 WCM. 06T308
ATUM 45XD2 WCM. 080412
ATUM 46XD2 WCM. 080412
ATUM 47XD2 WCM. 080412
ATUM 48XD2 WCM. 080412
ATUM 49XD2 WCM. 080412
ATUM 50XD2 WCM. 080412
ATUM 51XD2 WCM. 080412
ATUM 52XD2 WCM. 080412
ATUM 53XD2 WCM. 080412
ATUM 54XD2 WCM. 080412
ATUM 55XD2 WCM. 080412
ATUM 56XD2 WCM. 080412
ATUM 57XD2 WCM. 080412
ATUM 58XD2 WCM. 080412
ATUM 59XD2 WCM. 080412
ATUM 60XD2 WCM. 080412

D3 WCM - (ISO)



ATUM 16XD3 WCM. 030208
ATUM 16.5XD3 WCM. 030208
ATUM 17XD3 WCM. 030208
ATUM 17.5XD3 WCM. 030208
ATUM 18XD3 WCM. 030208
ATUM 18.5XD3 WCM. 030208
ATUM 19XD3 WCM. 030208
ATUM 19.5XD3 WCM. 030208
ATUM 20XD3 WCM. 040208
ATUM 20.5XD3 WCM. 040208
ATUM 21XD3 WCM. 040208
ATUM 21.5XD3 WCM. 040208
ATUM 22XD3 WCM. 040208
ATUM 22.5XD3 WCM. 040208
ATUM 23XD3 WCM. 040208
ATUM 23.5XD3 WCM. 040208
ATUM 24XD3 WCM. 050308
ATUM 24.5XD3 WCM. 050308
ATUM 25XD3 WCM. 050308
ATUM 25.5XD3 WCM. 050308
ATUM 26XD3 WCM. 050308
ATUM 26.5XD3 WCM. 050308
ATUM 27XD3 WCM. 050308
ATUM 27.5XD3 WCM. 050308
ATUM 28XD3 WCM. 050308
ATUM 28.5XD3 WCM. 050308
ATUM 29XD3 WCM. 050308
ATUM 29.5XD3 WCM. 050308
ATUM 30XD3 WCM. 06T308
ATUM 30.5XD3 WCM. 06T308
ATUM 31XD3 WCM. 06T308
ATUM 31.5XD3 WCM. 06T308
ATUM 32XD3 WCM. 06T308
ATUM 32.5XD3 WCM. 06T308
ATUM 33XD3 WCM. 06T308
ATUM 33.5XD3 WCM. 06T308
ATUM 34XD3 WCM. 06T308
ATUM 34.5XD3 WCM. 06T308
ATUM 35XD3 WCM. 06T308
ATUM 35.5XD3 WCM. 06T308
ATUM 36XD3 WCM. 06T308
ATUM 36.5XD3 WCM. 06T308
ATUM 37XD3 WCM. 06T308
ATUM 37.5XD3 WCM. 06T308
ATUM 38XD3 WCM. 06T308
ATUM 38.5XD3 WCM. 06T308
ATUM 39XD3 WCM. 06T308
ATUM 39.5XD3 WCM. 06T308
ATUM 40XD3 WCM. 06T308
ATUM 40.5XD3 WCM. 06T308
ATUM 41XD3 WCM. 06T308
ATUM 41.5XD3 WCM. 06T308
ATUM 42XD3 WCM. 06T308
ATUM 42.5XD3 WCM. 06T308
ATUM 43XD3 WCM. 06T308
ATUM 43.5XD3 WCM. 06T308
ATUM 44XD3 WCM. 06T308
ATUM 44.5XD3 WCM. 06T308
ATUM 45XD3 WCM. 080412
ATUM 45.5XD3 WCM. 080412
ATUM 46XD3 WCM. 080412
ATUM 47XD3 WCM. 080412
ATUM 48XD3 WCM. 080412
ATUM 49XD3 WCM. 080412
ATUM 50XD3 WCM. 080412
ATUM 51XD3 WCM. 080412
ATUM 52XD3 WCM. 080412
ATUM 53XD3 WCM. 080412
ATUM 54XD3 WCM. 080412
ATUM 55XD3 WCM. 080412
ATUM 56XD3 WCM. 080412
ATUM 57XD3 WCM. 080412
ATUM 58XD3 WCM. 080412
ATUM 59XD3 WCM. 080412
ATUM 60XD3 WCM. 080412

Delik Delme ve İşleme Takımları / Drilling and Holemaking Tools

Takma Uçlu Matkaplar / U-Drill System

D4 WCM - (ISO)



ATUM 16XD4 WCM. 030208
 ATUM 17XD4 WCM. 030208
 ATUM 17.5XD4 WCM. 030208
 ATUM 18XD4 WCM. 030208
 ATUM 19XD4 WCM. 030208
 ATUM 20XD4 WCM. 040208
 ATUM 21XD4 WCM. 040208
 ATUM 22XD4 WCM. 040208
 ATUM 22.5XD4 WCM. 040208
 ATUM 23XD4 WCM. 040208
 ATUM 24XD4 WCM. 050308
 ATUM 25XD4 WCM. 050308
 ATUM 26XD4 WCM. 050308
 ATUM 26.5XD4 WCM. 050308
 ATUM 27XD4 WCM. 050308
 ATUM 28XD4 WCM. 050308
 ATUM 28.5XD4 WCM. 050308
 ATUM 29XD4 WCM. 050308
 ATUM 30XD4 WCM. 06T308
 ATUM 31XD4 WCM. 06T308
 ATUM 32XD4 WCM. 06T308
 ATUM 33XD4 WCM. 06T308
 ATUM 33.5XD4 WCM. 06T308
 ATUM 34XD4 WCM. 06T308
 ATUM 35XD4 WCM. 06T308
 ATUM 36XD4 WCM. 06T308
 ATUM 37XD4 WCM. 06T308
 ATUM 38XD4 WCM. 06T308
 ATUM 38.5XD4 WCM. 06T308
 ATUM 39XD4 WCM. 06T308
 ATUM 40XD4 WCM. 06T308
 ATUM 41XD4 WCM. 06T308
 ATUM 42XD4 WCM. 06T308
 ATUM 43XD4 WCM. 06T308
 ATUM 44XD4 WCM. 06T308
 ATUM 45XD4 WCM. 080412
 ATUM 46XD4 WCM. 080412
 ATUM 47XD4 WCM. 080412
 ATUM 48XD4 WCM. 080412
 ATUM 49XD4 WCM. 080412
 ATUM 50XD4 WCM. 080412

D2 SP.. - SPMX (AKKO) - SPMG (TGTC)



ATUM 12.5XD2 SP. 050204
 ATUM 13XD2 SP. 050204
 ATUM 13.5XD2 SP. 050204
 ATUM 14XD2 SP. 050204
 ATUM 14.5XD2 SP. 050204
 ATUM 15XD2 SP. 050204
 ATUM 15.5XD2 SP. 060204
 ATUM 16XD2 SP. 060204
 ATUM 16.5XD2 SP. 060204
 ATUM 17XD2 SP. 060204
 ATUM 17.5XD2 SP. 060204
 ATUM 18XD2 SP. 060204
 ATUM 18.5D2 SP. 060204
 ATUM 19XD2 SP. 060204
 ATUM 19.5XD2 SP. 060204
 ATUM 20XD2 SP. 060204
 ATUM 20.5XD2 SP. 060204
 ATUM 21XD2 SP. 060204
 ATUM 21.5XD2 SP. 060204
 ATUM 22XD2 SP. 07T308
 ATUM 22.5XD2 SP. 07T308
 ATUM 23XD2 SP. 07T308
 ATUM 23.5XD2 SP. 07T308
 ATUM 24XD2 SP. 07T308
 ATUM 24.5XD2 SP. 07T308
 ATUM 25XD2 SP. 07T308
 ATUM 25.5XD2 SP. 07T308
 ATUM 26XD2 SP. 07T308
 ATUM 26.5XD2 SP. 07T308
 ATUM 27XD2 SP. 07T308
 ATUM 27.5XD2 SP. 07T308
 ATUM 28XD2 SP. 090408
 ATUM 28.5XD2 SP. 090408
 ATUM 29XD2 SP. 090408
 ATUM 29.5XD2 SP. 090408
 ATUM 30XD2 SP. 090408
 ATUM 31XD2 SP. 090408
 ATUM 32XD2 SP. 090408
 ATUM 33XD2 SP. 090408
 ATUM 34XD2 SP. 110408
 ATUM 35XD2 SP. 110408
 ATUM 36XD2 SP. 110408
 ATUM 37XD2 SP. 110408
 ATUM 38XD2 SP. 110408
 ATUM 39XD2 SP. 110408
 ATUM 40XD2 SP. 110408
 ATUM 41XD2 SP. 110408
 ATUM 42XD2 SP. 140512
 ATUM 43XD2 SP. 140512
 ATUM 44XD2 SP. 140512
 ATUM 45XD2 SP. 140512
 ATUM 46XD2 SP. 140512
 ATUM 47XD2 SP. 140512
 ATUM 48XD2 SP. 140512
 ATUM 49XD2 SP. 140512
 ATUM 50XD2 SP. 140512

D5 WCM - (ISO)



ATUM 20XD5 WCM. 040208
 ATUM 21XD5 WCM. 040208
 ATUM 22XD5 WCM. 040208
 ATUM 23XD5 WCM. 040208
 ATUM 24XD5 WCM. 050308
 ATUM 25XD5 WCM. 050308
 ATUM 26XD5 WCM. 050308
 ATUM 27XD5 WCM. 050308
 ATUM 28XD5 WCM. 050308
 ATUM 29XD5 WCM. 050308
 ATUM 30XD5 WCM. 06T308
 ATUM 31XD5 WCM. 06T308
 ATUM 32XD5 WCM. 06T308
 ATUM 33XD5 WCM. 06T308
 ATUM 34XD5 WCM. 06T308
 ATUM 35XD5 WCM. 06T308
 ATUM 37XD5 WCM. 06T308
 ATUM 38XD5 WCM. 06T308
 ATUM 46XD5 WCM. 080412

Takma Uçlu Matkaplar / U-Drill System

D3

SP.. - SPMX (AKKO)
- SPMG (TGTC)



ATUM 12.5XD3 SP.. 050204
ATUM 13XD3 SP.. 050204
ATUM 13.5XD3 SP.. 050204
ATUM 14XD3 SP.. 050204
ATUM 14.5XD3 SP.. 050204
ATUM 15XD3 SP.. 050204
ATUM 15.5XD3 SP.. 060204
ATUM 16XD3 SP.. 060204
ATUM 16.5XD3 SP.. 060204
ATUM 17XD3 SP.. 060204
ATUM 17.5XD3 SP.. 060204
ATUM 18XD3 SP.. 060204
ATUM 18.5XD3 SP.. 060204
ATUM 19XD3 SP.. 060204
ATUM 19.5XD3 SP.. 060204
ATUM 20XD3 SP.. 060204
ATUM 20.5XD3 SP.. 060204
ATUM 21XD3 SP.. 060204
ATUM 21.5XD3 SP.. 060204
ATUM 22XD3 SP.. 07T308
ATUM 22.5XD3 SP.. 07T308
ATUM 23XD3 SP.. 07T308
ATUM 23.5XD3 SP.. 07T308
ATUM 24XD3 SP.. 07T308
ATUM 24.5XD3 SP.. 07T308
ATUM 25XD3 SP.. 07T308
ATUM 25.5XD3 SP.. 07T308
ATUM 26XD3 SP.. 07T308
ATUM 26.5XD3 SP.. 07T308
ATUM 27XD3 SP.. 07T308
ATUM 27.5XD3 SP.. 07T308
ATUM 28XD3 SP.. 090408
ATUM 28.5XD3 SP.. 090408
ATUM 29XD3 SP.. 090408
ATUM 29.5XD3 SP.. 090408
ATUM 30XD3 SP.. 090408
ATUM 30.5XD3 SP.. 090408
ATUM 31XD3 SP.. 090408
ATUM 31.5XD3 SP.. 090408
ATUM 32XD3 SP.. 090408
ATUM 32.5XD3 SP.. 090408
ATUM 33XD3 SP.. 090408
ATUM 33.5XD3 SP.. 090408
ATUM 34XD3 SP.. 110408
ATUM 34.5XD3 SP.. 110408
ATUM 35XD3 SP.. 110408
ATUM 35.5XD3 SP.. 110408
ATUM 36XD3 SP.. 110408
ATUM 36.5XD3 SP.. 110408
ATUM 37XD3 SP.. 110408
ATUM 37.5XD3 SP.. 110408
ATUM 38XD3 SP.. 110408
ATUM 38.5XD3 SP.. 110408
ATUM 39XD3 SP.. 110408
ATUM 39.5XD3 SP.. 110408
ATUM 40XD3 SP.. 110408
ATUM 40.5XD3 SP.. 110408
ATUM 41XD3 SP.. 110408
ATUM 41.5XD3 SP.. 110408
ATUM 42XD3 SP.. 140512
ATUM 42.5XD3 SP.. 140512
ATUM 43XD3 SP.. 140512
ATUM 43.5XD3 SP.. 140512
ATUM 44XD3 SP.. 140512
ATUM 44.5XD3 SP.. 140512
ATUM 45XD3 SP.. 140512
ATUM 45.5XD3 SP.. 140512
ATUM 46XD3 SP.. 140512
ATUM 47XD3 SP.. 140512
ATUM 48XD3 SP.. 140512
ATUM 49XD3 SP.. 140512
ATUM 50XD3 SP.. 140512
ATUM 51XD3 SP.. 140512
ATUM 52XD3 SP.. 140512

D4

SP.. - SPMX (AKKO)
- SPMG (TGTC)



ATUM 13XD4 SP.. 050204
ATUM 14XD4 SP.. 050204
ATUM 15XD4 SP.. 050204
ATUM 16XD4 SP.. 060204
ATUM 17XD4 SP.. 060204
ATUM 17.5XD4 SP.. 060204
ATUM 18XD4 SP.. 060204
ATUM 19XD4 SP.. 060204
ATUM 19.5XD4 SP.. 060204
ATUM 20XD4 SP.. 060204
ATUM 21XD4 SP.. 060204
ATUM 22XD4 SP.. 07T308
ATUM 23XD4 SP.. 07T308
ATUM 23.5XD4 SP.. 07T308
ATUM 24XD4 SP.. 07T308
ATUM 25XD4 SP.. 07T308
ATUM 26XD4 SP.. 07T308
ATUM 27XD4 SP.. 07T308
ATUM 27.5XD4 SP.. 07T308
ATUM 28XD4 SP.. 090408
ATUM 29XD4 SP.. 090408
ATUM 30XD4 SP.. 090408
ATUM 31XD4 SP.. 090408
ATUM 32XD4 SP.. 090408
ATUM 33XD4 SP.. 090408
ATUM 33.5XD4 SP.. 090408
ATUM 34XD4 SP.. 110408
ATUM 35XD4 SP.. 110408
ATUM 36XD4 SP.. 110408
ATUM 37XD4 SP.. 110408
ATUM 38XD4 SP.. 110408
ATUM 39XD4 SP.. 110408
ATUM 40XD4 SP.. 110408
ATUM 41XD4 SP.. 110408
ATUM 42XD4 SP.. 140512
ATUM 43XD4 SP.. 140512
ATUM 44XD4 SP.. 140512

D5

SP.. - SPMX (AKKO)
- SPMG (TGTC)



ATUM 14XD5 SP.. 050204
ATUM 16XD5 SP.. 060204
ATUM 17XD5 SP.. 060204
ATUM 18XD5 SP.. 060204
ATUM 19XD5 SP.. 060204
ATUM 20XD5 SP.. 060204
ATUM 21XD5 SP.. 060204
ATUM 22XD5 SP.. 07T308
ATUM 22XD5 SP.. 07T308-32
ATUM 23XD5 SP.. 07T308
ATUM 23XD5 SP.. 07T308-32
ATUM 24XD5 SP.. 07T308-32
ATUM 25XD5 SP.. 07T308
ATUM 25XD5 SP.. 07T308-32
ATUM 26XD5 SP.. 07T308
ATUM 26XD5 SP.. 07T308-32
ATUM 27XD5 SP.. 07T308
ATUM 27XD5 SP.. 07T308-32
ATUM 28XD5 SP.. 090408-32
ATUM 29XD5 SP.. 090408-32
ATUM 30XD5 SP.. 090408
ATUM 31XD5 SP.. 090408
ATUM 32XD5 SP.. 090408
ATUM 33XD5 SP.. 090408

Delik Delme ve İşleme Takımları / Drilling and Holemaking Tools

Takma Uçlu Matkaplar / U-Drill System

D2 SPGT - (ZCC)



ATUM 12.5XD2 SPGT 050204
 ATUM 13XD2 SPGT 050204
 ATUM 13.5XD2 SPGT 050204
 ATUM 14XD2 SPGT 050204
 ATUM 15XD2 SPGT 050204
 ATUM 16XD2 SPGT 060204
 ATUM 16.5XD2 SPGT 060204
 ATUM 17XD2 SPGT 060204
 ATUM 17.5XD2 SPGT 060204
 ATUM 18XD2 SPGT 060204
 ATUM 19XD2 SPGT 060204
 ATUM 20XD2 SPGT 060204
 ATUM 22XD2 SPGT 07T308
 ATUM 22.5XD2 SPGT 07T308
 ATUM 23XD2 SPGT 07T308
 ATUM 24XD2 SPGT 07T308
 ATUM 25XD2 SPGT 07T308
 ATUM 26XD2 SPGT 07T308
 ATUM 28XD2 SPGT 090408
 ATUM 29XD2 SPGT 090408
 ATUM 30XD2 SPGT 090408
 ATUM 32XD2 SPGT 090408
 ATUM 35XD2 SPGT 110408
 ATUM 36XD2 SPGT 110408
 ATUM 40XD2 SPGT 110408

D3 SPGT - (ZCC)



ATUM 12.5XD3 SPGT 050204
 ATUM 13XD3 SPGT 050204
 ATUM 13.5XD3 SPGT 050204
 ATUM 14XD3 SPGT 050204
 ATUM 14.5XD3 SPGT 050204
 ATUM 15XD3 SPGT 050204
 ATUM 15.5XD3 SPGT 060204
 ATUM 16XD3 SPGT 060204
 ATUM 16.5XD3 SPGT 060204
 ATUM 17XD3 SPGT 060204
 ATUM 17.5XD3 SPGT 060204
 ATUM 18XD3 SPGT 060204
 ATUM 18.5XD3 SPGT 060204
 ATUM 19XD3 SPGT 060204
 ATUM 19.5XD3 SPGT 060204
 ATUM 20XD3 SPGT 060204
 ATUM 20.5XD3 SPGT 060204
 ATUM 21XD3 SPGT 060204
 ATUM 21.5XD3 SPGT 060204
 ATUM 22XD3 SPGT 07T308
 ATUM 22.5XD3 SPGT 07T308
 ATUM 23XD3 SPGT 07T308
 ATUM 23.5XD3 SPGT 07T308
 ATUM 24XD3 SPGT 07T308
 ATUM 24.5XD3 SPGT 07T308
 ATUM 25XD3 SPGT 07T308
 ATUM 25.5XD3 SPGT 07T308
 ATUM 26XD3 SPGT 07T308
 ATUM 26.5XD3 SPGT 07T308
 ATUM 27XD3 SPGT 07T308
 ATUM 27.5XD3 SPGT 07T308
 ATUM 28XD3 SPGT 090408

D3 SPGT - (ZCC)



ATUM 28.5XD3 SPGT 090408
 ATUM 29XD3 SPGT 090408
 ATUM 29.5XD3 SPGT 090408
 ATUM 30XD3 SPGT 090408
 ATUM 31XD3 SPGT 090408
 ATUM 32XD3 SPGT 090408
 ATUM 33XD3 SPGT 090408
 ATUM 34XD3 SPGT 110408
 ATUM 35XD3 SPGT 110408
 ATUM 37XD3 SPGT 110408
 ATUM 38XD3 SPGT 110408
 ATUM 39XD3 SPGT 110408
 ATUM 40XD3 SPGT 110408
 ATUM 42XD3 SPGT 140512
 ATUM 43XD3 SPGT 140512
 ATUM 44XD3 SPGT 140512
 ATUM 49XD3 SPGT 140512
 ATUM 50XD3 SPGT 140512

D4 SPGT - (ZCC)



ATUM 13XD4 SPGT 050204
 ATUM 14XD4 SPGT 050204
 ATUM 15XD4 SPGT 050204
 ATUM 16XD4 SPGT 060204
 ATUM 17XD4 SPGT 060204
 ATUM 17.5XD4 SPGT 060204
 ATUM 18XD4 SPGT 060204
 ATUM 19XD4 SPGT 060204
 ATUM 19.5XD4 SPGT 060204
 ATUM 20XD4 SPGT 060204
 ATUM 21XD4 SPGT 060204
 ATUM 22XD4 SPGT 07T308
 ATUM 23XD4 SPGT 07T308
 ATUM 23.5XD4 SPGT 07T308
 ATUM 24XD4 SPGT 07T308
 ATUM 25XD4 SPGT 07T308
 ATUM 26XD4 SPGT 07T308
 ATUM 27.5XD4 SPGT 07T308
 ATUM 28XD4 SPGT 090408
 ATUM 29XD4 SPGT 090408
 ATUM 30XD4 SPGT 090408
 ATUM 33.5XD4 SPGT 090408
 ATUM 38XD4 SPGT 110408

D3 SO.. - SOMX-SOMT (ISCR)



ATUM 14XD3 SO.. 050204
 ATUM 15XD3 SO.. 050204
 ATUM 16XD3 SO.. 050204
 ATUM 16.5XD3 SO.. 050204
 ATUM 17XD3 SO.. 050204
 ATUM 17.5XD3 SO.. 050204
 ATUM 18XD3 SO.. 060304
 ATUM 19XD3 SO.. 060204
 ATUM 20XD3 SO.. 060304
 ATUM 21XD3 SO.. 070305
 ATUM 22XD3 SO.. 070305
 ATUM 22.5XD3 SO.. 070305
 ATUM 23XD3 SO.. 070305
 ATUM 24XD3 SO.. 070305
 ATUM 25XD3 SO.. 09T306
 ATUM 26XD3 SO.. 09T306
 ATUM 27XD3 SO.. 09T306
 ATUM 29XD3 SO.. 09T306
 ATUM 30XD3 SO.. 09T306

Takma Uçlu Matkaplar / U-Drill System

D3 SO.. - SOMX-SOMT (ISCR)



ATUM 31XD3 SO.. 09T306
ATUM 33XD3 SO.. 09T306
ATUM 35XD3 SO.. 120408
ATUM 36XD3 SO.. 120408
ATUM 37XD3 SO.. 120408
ATUM 38XD3 SO.. 120408
ATUM 39XD3 SO.. 120408
ATUM 40XD3 SO.. 120408
ATUM 43XD3 SO.. 120408

D4 SO.. - SOMX-SOMT (ISCR)



ATUM 14XD4 SO.. 050204
ATUM 14.5XD4 SO.. 050204
ATUM 15XD4 SO.. 050204
ATUM 15.5XD4 SO.. 050204
ATUM 17XD4 SO.. 050204
ATUM 19XD4 SO.. 060304
ATUM 19.5XD4 SO.. 060304
ATUM 20XD4 SO.. 060304
ATUM 21XD4 SO.. 070305
ATUM 22XD4 SO.. 070305
ATUM 22.5XD4 SO.. 070305
ATUM 23XD4 SO.. 070305
ATUM 24XD4 SO.. 070305
ATUM 25XD4 SO.. 09T306
ATUM 27XD4 SO.. 09T306
ATUM 28XD4 SO.. 09T306
ATUM 29XD4 SO.. 09T306
ATUM 30XD4 SO.. 09T306
ATUM 31XD4 SO.. 09T306
ATUM 33XD4 SO.. 09T306
ATUM 34XD4 SO.. 09T306
ATUM 35XD4 SO.. 120408

D2 KDR - SPMT-XOMT (KRLY)



ATUM 14XD2 KDR 0502..
ATUM 18XD2 KDR 0602..
ATUM 20XD2 KDR 07T2..
ATUM 22XD2 KDR 07T2..
ATUM 24XD2 KDR 0903..
ATUM 25XD2 KDR 0903..
ATUM 26XD2 KDR 0903..
ATUM 28XD2 KDR 0903..
ATUM 30XD2 KDR 11T3..
ATUM 32XD2 KDR 11T3..
ATUM 34XD2 KDR 11T3..
ATUM 37XD2 KDR 1304..

D4 KDR - SPMT-XOMT (KRLY)



ATUM 14XD4 KDR 0502..
ATUM 14.5XD4 KDR 0502..
ATUM 15XD4 KDR 0502..
ATUM 15.5XD4 KDR 0502..
ATUM 16XD4 KDR 0502..
ATUM 17XD4 KDR 0602..
ATUM 17.5XD4 KDR 0602..
ATUM 18XD4 KDR 0602..
ATUM 18.5XD4 KDR 0602..
ATUM 19XD4 KDR 0602..
ATUM 20XD4 KDR 07T2..
ATUM 21XD4 KDR 07T2..
ATUM 22XD4 KDR 07T2..
ATUM 24XD4 KDR 0903..
ATUM 25XD4 KDR 0903..

D3 KDR - SPMT-XOMT (KRLY)



ATUM 12.5XD3 KDR 0402..
ATUM 13XD3 KDR 0402..
ATUM 14XD3 KDR 0502..
ATUM 14.5XD3 KDR 0502..
ATUM 15XD3 KDR 0502..
ATUM 15.5XD3 KDR 0502..
ATUM 16XD3 KDR 0502..
ATUM 16.5XD3 KDR 0602..
ATUM 17XD3 KDR 0602..
ATUM 17.5XD3 KDR 0602..
ATUM 18XD3 KDR 0602..
ATUM 18.5XD3 KDR 0602..
ATUM 19XD3 KDR 0602..
ATUM 19.5XD3 KDR 0602..
ATUM 20XD3 KDR 07T2..
ATUM 20.5XD3 KDR 07T2..
ATUM 21XD3 KDR 07T2..
ATUM 22XD3 KDR 07T2..
ATUM 23XD3 KDR 07T2..
ATUM 23.5XD3 KDR 07T2..
ATUM 24XD3 KDR 0903..
ATUM 24.5XD3 KDR 0903..
ATUM 25XD3 KDR 0903..
ATUM 26XD3 KDR 0903..
ATUM 27XD3 KDR 0903..
ATUM 28XD3 KDR 0903..
ATUM 29XD3 KDR 0903..
ATUM 30XD3 KDR 11T3..
ATUM 32XD3 KDR 11T3..
ATUM 33XD3 KDR 11T3..
ATUM 34XD3 KDR 11T3..
ATUM 35XD3 KDR 11T3..
ATUM 37XD3 KDR 1304..
ATUM 38XD3 KDR 1304..
ATUM 39XD3 KDR 1304..
ATUM 40XD3 KDR 1304..

D2 SOMT - (TGTC)



ATUM 14XD2 SOMT 050204
ATUM 16XD2 SOMT 050204
ATUM 17XD2 SOMT 060204
ATUM 18XD2 SOMT 060204
ATUM 20XD2 SOMT 070306
ATUM 22XD2 SOMT 070306
ATUM 23XD2 SOMT 08T306
ATUM 24XD2 SOMT 08T306
ATUM 25XD2 SOMT 08T306
ATUM 26XD2 SOMT 08T306
ATUM 27XD2 SOMT 09T308
ATUM 28XD2 SOMT 09T308
ATUM 29XD2 SOMT 09T308
ATUM 30XD2 SOMT 09T308
ATUM 32XD2 SOMT 11T308
ATUM 33XD2 SOMT 11T308
ATUM 34XD2 SOMT 11T308
ATUM 35XD2 SOMT 11T308
ATUM 37XD2 SOMT 130408
ATUM 38XD2 SOMT 130408
ATUM 40XD2 SOMT 130408
ATUM 45XD2 SOMT 150510
ATUM 47XD2 SOMT 150510

Delik Delme ve İşleme Takımları / Drilling and Holemaking Tools
D3 SOMT - (TGTC)

ATUM 14XD3 SOMT 050204
 ATUM 14.5XD3 SOMT 050204
 ATUM 15XD3 SOMT 050204
 ATUM 15.5XD3 SOMT 050204
 ATUM 16XD3 SOMT 050204
 ATUM 16.5XD3 SOMT 060204
 ATUM 17XD3 SOMT 060204
 ATUM 17.5XD3 SOMT 060204
 ATUM 18XD3 SOMT 060204
 ATUM 18.5XD3 SOMT 060204
 ATUM 19XD3 SOMT 060204
 ATUM 19.5XD3 SOMT 070306
 ATUM 20XD3 SOMT 070306
 ATUM 20.5XD3 SOMT 070306
 ATUM 21XD3 SOMT 070306
 ATUM 22XD3 SOMT 070306
 ATUM 22.5XD3 SOMT 08T306
 ATUM 23XD3 SOMT 08T306
 ATUM 23.5XD3 SOMT 08T306
 ATUM 24XD3 SOMT 08T306
 ATUM 24.5XD3 SOMT 08T306
 ATUM 25XD3 SOMT 08T306
 ATUM 26XD3 SOMT 08T306
 ATUM 27XD3 SOMT 09T308
 ATUM 27.5XD3 SOMT 09T308
 ATUM 28XD3 SOMT 09T308
 ATUM 29XD3 SOMT 09T308
 ATUM 30XD3 SOMT 09T308
 ATUM 32XD3 SOMT 11T308
 ATUM 33XD3 SOMT 11T308
 ATUM 34XD3 SOMT 11T308
 ATUM 35XD3 SOMT 11T308
 ATUM 36XD3 SOMT 11T308
 ATUM 37XD3 SOMT 130408
 ATUM 38XD3 SOMT 130408
 ATUM 39XD3 SOMT 130408
 ATUM 40XD3 SOMT 130408
 ATUM 45XD3 SOMT 150510
 ATUM 49XD3 SOMT 150510
 ATUM 50XD3 SOMT 150510

D5 SOMT - (TGTC)

ATUM 14XD5 SOMT 050204
 ATUM 15XD5 SOMT 050204
 ATUM 16XD5 SOMT 050204
 ATUM 17.5XD5 SOMT 060204
 ATUM 18XD5 SOMT 060204
 ATUM 19XD5 SOMT 060204
 ATUM 19.5XD5 SOMT 070306
 ATUM 20XD5 SOMT 070306
 ATUM 21XD5 SOMT 070306
 ATUM 22XD5 SOMT 070306
 ATUM 23XD5 SOMT 08T306
 ATUM 24XD5 SOMT 08T306
 ATUM 25XD5 SOMT 08T306
 ATUM 26XD5 SOMT 08T306
 ATUM 27XD5 SOMT 09T308
 ATUM 28XD5 SOMT 09T308
 ATUM 29XD5 SOMT 09T308
 ATUM 30XD5 SOMT 09T308
 ATUM 33XD5 SOMT 11T308
 ATUM 34XD5 SOMT 11T308
 ATUM 35XD5 SOMT 11T308
 ATUM 36XD5 SOMT 11T308

D3 880... (SNDVK)

ATUM 14XD3 880-0202..
 ATUM 14.5XD3 880-0202..
 ATUM 15XD3 880-0202..
 ATUM 15.5XD3 880-0202..
 ATUM 16XD3 880-0202..
 ATUM 16.5XD3 880-0303..
 ATUM 17XD3 880-0303..
 ATUM 17.5XD3 880-0303..
 ATUM 18XD3 880-0303..
 ATUM 18.5XD3 880-0303..
 ATUM 19XD3 880-0303..
 ATUM 19.5XD3 880-0303..
 ATUM 20XD3 880-0403..
 ATUM 20.5XD3 880-0403..
 ATUM 21XD3 880-0403..
 ATUM 21.5XD3 880-0403..
 ATUM 22XD3 880-0403..
 ATUM 23XD3 880-0403..
 ATUM 24XD3 880-0503..
 ATUM 25XD3 880-0503..
 ATUM 26XD3 880-0503..
 ATUM 27XD3 880-0503..
 ATUM 28XD3 880-0503..
 ATUM 29XD3 880-0503..
 ATUM 30XD3 880-0604..
 ATUM 31XD3 880-0604..
 ATUM 32XD3 880-0604..
 ATUM 33XD3 880-0604..
 ATUM 34XD3 880-0604..
 ATUM 35XD3 880-0604..
 ATUM 36XD3 880-0704..
 ATUM 38XD3 880-0704..
 ATUM 39XD3 880-0704..
 ATUM 40XD3 880-0704..
 ATUM 41XD3 880-0704..
 ATUM 42XD3 880-0704..
 ATUM 45XD3 880-0805..
 ATUM 46XD3 880-0805..
 ATUM 48XD3 880-0805..
 ATUM 50XD3 880-0805..

D4 SOMT - (TGTC)

ATUM 14XD4 SOMT 050204
 ATUM 14.5XD4 SOMT 050204
 ATUM 16XD4 SOMT 050204
 ATUM 17XD4 SOMT 060204
 ATUM 17.5XD4 SOMT 060204
 ATUM 18XD4 SOMT 060204
 ATUM 19XD4 SOMT 060204
 ATUM 20XD4 SOMT 070306
 ATUM 21XD4 SOMT 070306
 ATUM 22XD4 SOMT 070306
 ATUM 24XD4 SOMT 08T306
 ATUM 25XD4 SOMT 08T306

Delik Pahlama Bileziği / Drill Chamfering Ring Tools

| ADCR | Takım Kodu / Tool Code |
|------|------------------------|
| | ADCR-120-VB1103 |
| | ADCR-125-VB1103 |
| | ADCR-130-VB1103 |
| | ADCR-135-VB1103 |
| | ADCR-140-VB1103 |
| | ADCR-145-VB1103 |
| | ADCR-150-VB1103 |
| | ADCR-155-VB1103 |
| | ADCR-160-VB1103 |
| | ADCR-165-VB1103 |
| | ADCR-170-VB1103 |
| | ADCR-175-VB1103 |
| | ADCR-180-VB1103 |
| | ADCR-185-VB1103 |
| | ADCR-190-VB1103 |
| | ADCR-195-VB1103 |
| | ADCR-200-VB1103 |
| | ADCR-205-VB1103 |
| | ADCR-210-VB1103 |
| | ADCR-215-VB1103 |
| | ADCR-220-VB1103 |
| | ADCR-225-VB1103 |
| | ADCR-230-VB1103 |
| | ADCR-235-VB1103 |
| | ADCR-240-VB1103 |
| | ADCR-245-VB1103 |
| | ADCR-250-VB1103 |
| | ADCR-255-VB1103 |
| | ADCR-260-VB1103 |
| | ADCR-265-VB1103 |
| | ADCR-270-VB1103 |
| | ADCR-275-VB1103 |
| | ADCR-280-VB1103 |
| | ADCR-285-VB1103 |
| | ADCR-290-VB1103 |
| | ADCR-295-VB1103 |
| | ADCR-300-VB1103 |



Ekokes-Delik Delme, Delik İçi ve Dış Çap Tornalama
Ekokes-Drilling, Boring and External Turning

| | |
|--|-----------------------------|
| | AEKR/L-D2.25X8 XC.. 040104 |
| | AEKR/L-D2.25X10 XC.. 050204 |
| | AEKR/L-D2.25X12 XC.. 060204 |
| | AEKR/L-D2.25X14 XC.. 070304 |
| | AEKR/L-D2.25X16 XC.. 080304 |
| | AEKR/L-D2.25X18 XC.. 09T304 |
| | AEKR/L-D2.25X20 XC.. 10T304 |
| | AEKR/L-D2.25X25 XC.. 130404 |
| | AEKR/L-D2.25X32 XC.. 170504 |



CRTZT-İSCR-TGTC-KRLY UCUNA UYGUNDUR
COMPATIBLE WITH CRTZT-İSCR-TGTC-KRLY INSERT

Eksantrik U-Drill Adaptörü / Excentric Adaptor For U-Drills

| | |
|--|---|
| | AET-2025 |
| | AET-2532 |
| | AET-3240 |
| | Ø+0.4 - Ø-0.2 ARASINDA ONDALIKLI OLARAK AYARLANABİLİR ÖR: Ø25 TAKIM = 24.8 ≈ 25.4 ARASI AYARLANABİLİR. |
| | CAN BE ADJUSTABLE BETWEEN Ø+0.4 - Ø-0.2 AS DECIMAL. FOR EXAMPLE: Ø25 TOOL; CAN BE ADJUSTABLE BETWEEN 24,8 ≈ 25,4 |



AET

Ayarlı Kaba Delik İşleme Baraları / Adjustable Rough Boring Heads

| Takım Kodu / Tool Code | Dmin-Dmax |
|-------------------------------|-----------|
| ABHR-D18x22-W16-L90-CC06 | 18-22 |
| ABHR-D18x22-W16-L150-CC06 | 18-22 |
| ABHR-D18x22-W16-L200-CC06 | 18-22 |
| ABHR-D22x28-W20-L100-CC06 | 22-28 |
| ABHR-D22x28-W20-L150-CC06 | 22-28 |
| ABHR-D22x28-W20-L200-CC06 | 22-28 |
| ABHR-D28x38-W20-L110-CC06 | 28-38 |
| ABHR-D28x38-W20-L160-CC06 | 28-38 |
| ABHR-D28x38-W20-L230-CC06 | 28-38 |
| ABHR-D36x50-W25-L120-CC06 | 36-50 |
| ABHR-D36x50-W25-L170-CC06 | 36-50 |
| ABHR-D36x50-W25-L250-CC06 | 36-50 |
| ABHR-D36x50-W25-L120-CC09 | 36-50 |
| ABHR-D36x50-W25-L170-CC09 | 36-50 |
| ABHR-D36x50-W25-L250-CC09 | 36-50 |
| ABHR-D50x68-W32-L140-CC09 | 50-68 |
| ABHR-D50x68-W32-L200-CC09 | 50-68 |
| ABHR-D50x68-W32-L280-CC09 | 50-68 |
| ABHR-D50x68-W32-L140-CC12 | 50-68 |
| ABHR-D50x68-W32-L200-CC12 | 50-68 |
| ABHR-D50x68-W32-L280-CC12 | 50-68 |
| ABHR-D68x90-W32-L160-CC12 | 68-90 |
| ABHR-D68x90-W32-L210-CC12 | 68-90 |
| ABHR-D68x90-W32-L280-CC12 | 68-90 |
| ABHR-D90x120-W32-L140-CC12 | 90-120 |
| ABHR-D90x120-W40-L200-CC12 | 90-120 |
| ABHR-D90x120-W40-L300-CC12 | 90-120 |
| ABHR-D120x160-W40-L210-CC12 | 120-160 |
| ABHR-D120x160-W40-L300-CC12 | 120-160 |
| ABHR-D160x200-W40-L210-B-CC12 | 160-200 |
| ABHR-D160x200-W40-L300-B-CC12 | 160-200 |

Ayarlı Kaba Delik İşleme Bara Gövdesi / Adjustable Rough Boring Heads Body

| Takım Kodu / Tool Code | Kartuş / Cartridge |
|------------------------|--------------------|
| ABHRS-D16x42-W16-L90 | AK.. 18-22 |
| ABHRS-D16x102-W16-L150 | AK.. 18-22 |
| ABHRS-D16x152-W16-L200 | AK.. 18-22 |
| ABHRS-D20x50-W20-L100 | AK.. 22-28 |
| ABHRS-D20x100-W20-L150 | AK.. 22-28 |
| ABHRS-D20x150-W20-L200 | AK.. 22-28 |
| ABHRS-D25x60-W20-L110 | AK.. 28-38 |
| ABHRS-D25x110-W20-L160 | AK.. 28-38 |
| ABHRS-D25x180-W20-L230 | AK.. 28-38 |
| ABHRS-D32x64-W25-L120 | AK.. 36-50 |
| ABHRS-D32x114-W25-L170 | AK.. 36-50 |
| ABHRS-D32x194-W25-L250 | AK.. 36-50 |
| ABHRS-D32x64-W25-L120 | AK.. 36-50-09 |
| ABHRS-D32x114-W25-L170 | AK.. 36-50-09 |
| ABHRS-D32x194-W25-L250 | AK.. 36-50-09 |
| ABHRS-D40x80-W32-L140 | AK.. 50-68 |
| ABHRS-D40x140-W32-L200 | AK.. 50-68 |
| ABHRS-D40x220-W32-L280 | AK.. 50-68 |
| ABHRS-D40x80-W32-L140 | AK.. 50-68-12 |
| ABHRS-D40x140-W32-L200 | AK.. 50-68-12 |
| ABHRS-D40x220-W32-L280 | AK.. 50-68-12 |
| ABHRS-D50x100-W32-L160 | AK.. 68-90 |
| ABHRS-D50x150-W32-L210 | AK.. 68-90 |
| ABHRS-D50x220-W32-L280 | AK.. 68-90 |
| ABHRS-D63x80-W32-L140 | AK.. 90-120 |
| ABHRS-D63x130-W40-L200 | AK.. 90-120 |
| ABHRS-D63x230-W40-L300 | AK.. 90-120 |
| ABHRS-D80x140-W40-L210 | AK.. 120-160 |
| ABHRS-D80x230-W40-L300 | AK.. 120-160 |
| ABHRS-D80x140-W40-L210 | AK.. 160-200 |
| ABHRS-D80x230-W40-L300 | AK.. 160-200 |



Frezeleme Takımları / Milling Tools

Ayarlı Kaba Delik İşleme Bara Kartuşları / Adjustable Rough Boring Heads Cartridge



| Takım Kodu / Tool Code | Ölçü Aralığı-Boring Range |
|------------------------|---------------------------|
| AKSR 18-22 | 18-22 |
| AKSR 22-28 | 22-28 |
| AKSR 28-38 | 28-38 |
| AKSR 36-50 | 36-50 |
| AKSR 36-50-09 | 36-50 |
| AKSR 50-68 | 50-68 |
| AKSR 50-68-12 | 50-68 |
| AKSR 68-90 | 68-90 |
| AKSR 90-120 | 90-120 |
| AKSR 120-160 | 120-160 |
| AKSR 160-200 | 160-200 |



| Takım Kodu / Tool Code | Ölçü Aralığı-Boring Range |
|------------------------|---------------------------|
| AKCR 28-38 | 28-38 |
| AKCR 36-50 | 36-50 |
| AKCR 36-50-09 | 36-50 |
| AKCR 50-68 | 50-68 |
| AKCR 50-68-12 | 50-68 |
| AKCR 68-90 | 68-90 |
| AKCR 90-120 | 90-120 |
| AKCR 120-160 | 120-160 |
| AKCR 160-200 | 160-200 |

Diş Açma Frezeleme Takımları Thread Milling Tools

| ° | ATM-C.. | Uç / Insert | Takım Kodu / Tool Code |
|---|---------------|---------------|----------------------------|
| ° | C14 (For CPT) | C14 (For CPT) | ATM-C14-D14-W20-L100-Z01-H |
| | | | ATM-C21-D18-W20-L100-Z01-H |
| | | | ATM-C21-D21-W25-L125-Z01-H |
| | | | ATM-C21-D25-W20-L125-Z01-H |
| | | | ATM-C21-D28-W25-L90-Z01-H |
| | | | ATM-C21-D38-W32-L90-Z03-H |
| | C21 (For CPT) | C21 (For CPT) | ATM-C21-D38-W32-L90-Z03-H |
| | | | ATM-C21-D38-W32-L120-Z03-H |
| | | | ATM-C21-D43-W32-L90-Z03-H |
| | | | ATM-C21-D43-W32-L150-Z01-H |
| | | | ATM-C30-D29-W25-L150-Z01-H |
| | | | ATM-C30-D29-W25-L150-Z01-H |

| ° | ATM-H.. | Uç / Insert | Takım Kodu / Tool Code |
|---|--------------------------------|--------------------------------|----------------------------|
| ° | H23 (For CPT) H32 (For CPT) | H23 (For CPT) H32 (For CPT) | ATM-H23-D23-C25-L100-Z02-H |
| | | | ATM-H32-D32-C32-L130-Z05-H |

| 60° | ATM60.. | Uç / Insert | Takım Kodu / Tool Code |
|-----|--|--|-----------------------------------|
| 60° | TBGT 060102 T.C.T 090202 T.C.T 110202 T.C.T 16T304 (For ISO) | TBGT 060102 T.C.T 090202 T.C.T 110202 T.C.T 16T304 (For ISO) | ATM60-TB0601-D13-C10-L150-Z02-H |
| | | | ATM60-TC0902-D20.5-C16-L150-Z02-H |
| | | | ATM60-TC1102-D26-C20-L150-Z03-H |
| | | | ATM60-TC16T3-D32-C25-L150-Z02-H |
| | | | ATM60-TC16T3-D40-C32-L250-Z03-H |

Silindirik Havşa Başlı Vida (DIN 974-1) Havşalarını Açma Frezeleri Countersink Milling Tool For Cylindrical Allen Head Screws (DIN 974-1)

| ° | ACBM.. | Uç / Insert | Takım Kodu / Tool Code |
|---|-------------------------|-------------------------|-----------------------------------|
| ° | CC. 0602.. (For ISO) | CC. 0602.. (For ISO) | ACBM-CC06-D17X6-W16-L150-Z02 |
| | | | ACBM-CC06-D18X7-W16-L100-Z02-H |
| | | | ACBM-CC06-D18X7-W16-L160-Z02-H |
| | | | ACBM-CC06-D20X9-W20-L100-Z02-H |
| | | | ACBM-CC06-D20X9-W20-L160-Z02-H |
| | | | ACBM-CC09-D26X8.5-W25-L130-Z02-H |
| | CC. 09T3.. (For ISO) | CC. 09T3.. (For ISO) | ACBM-CC09-D26X8.5-W25-L200-Z02 |
| | | | ACBM-CC09-D30X12.5-W32-L130-Z02-H |
| | | | ACBM-CC09-D33X15.5-W32-L130-Z02-H |
| | | | ACBM-CC09-D33X15.5-W32-L200-Z2 |
| | | | ACBM-SP06-D15X4-W16-L160-Z02-H |
| | | | ACBM-SP06-D15X4-W16-L160-Z02-H |

Pah Frezeler / Chamfering Tools

| ° | ACM..-TC.. | Uç / Insert | Takım Kodu / Tool Code |
|---|------------|-------------|------------------------------------|
| ° | ACM..-TC.. | Uç / Insert | ACM10-TC16-D17X22-W16-L90-Z01 |
| | | | ACM15-TC16-D17X24-W16-L90-Z01 |
| | | | ACM15-TC16-D22X29-W16-L100-Z01 |
| | | | ACM15-TC16-D30X37-W20-L100-Z02 |
| | | | ACM15-TC16-D35X42-W20-L100-Z03 |
| | | | ACM15-TC16-D52X59-W25-L110-Z03 |
| | | | ACM17.5-TC16-D17X25-W16-L90-Z01 |
| | | | ACM18.5-TC16-D21.3X30-W20-L100-Z02 |
| | | | ACM20-TC16-D12X22-W16-L100-Z01 |
| | | | ACM20-TC16-D17X27-W16-L100-Z01 |
| | | | ACM20-TC16-D23X33-W20-L100-Z02 |
| | | | ACM20-TC16-D28X38-W20-L100-Z02 |
| | | | TCT 16T304 |
| | | | ACM20-TC16-D35X45-W20-L100-Z03 |
| | | | ACM20-TC16-D39X49-W20-L100-Z03 |
| | | | ACM20-TC16-D45X55-W25-L110-Z03 |
| | | | ACM20-TC16-D51X61-W25-L110-Z03 |
| | | | ACM22.5-TC16-D17X28-W16-L100-Z01 |
| | | | ACM25-TC16-D17X29-W16-L100-Z01 |
| | | | ACM30-TC16-D6X20-W16-L100-Z01 |
| | | | ACM30-TC16-D15X30-W16-L100-Z01 |
| | | | ACM30-TC16-D17.5X32.5-W20-L100-Z02 |
| | | | ACM30-TC16-D20X35-W16-L100-Z02 |
| | | | ACM30-TC16-D30X45-W20-L100-Z02 |
| | | | ACM30-TC16-D35X50-W20-L100-Z03 |
| | | | ACM30-TC16-D45X60-W25-L110-Z03 |
| | | | TCT 090204 |
| | | | TCT 110204 |
| | | | ACM45-TC09-D7X18-W16-L100-Z02 |
| | | | ACM45-TC11-D11X24-W16-L100-Z02 |
| | | | ACM45-TC16-D5X26-W16-L100-Z01 |
| | | | ACM45-TC16-D10X31-W16-L100-Z02 |
| | | | ACM45-TC16-D10X31-W20-L100-Z02 |
| | | | ACM45-TC16-D18X39-W16-L100-Z02 |
| | | | TCT 16T304 |
| | | | ACM45-TC16-D18X39-W20-L100-Z02 |
| | | | ACM45-TC16-D20X41-W20-L100-Z02 |
| | | | ACM45-TC16-D30X51-W20-L100-Z02 |
| | | | ACM55-TC16-D16X40-W20-L100-Z03 |
| | | | ACM62-TC16-D14X40-W20-L100-Z03 |
| | | | ACM72-TC16-D14X42-W20-L100-Z03 |

| 45° | ACM45-SP11 | Uç / Insert | Takım Kodu / Tool Code |
|-----|------------|--------------------------|----------------------------------|
| 45° | ACM45-SP11 | SPGT 110408 (For ZCC) | ACM45-SP1104-D12x26-W20-L150-Z01 |
| | | | ACM45-SP1104-D25x39-W25-L150-Z02 |
| | | | ACM45-SP1104-D32x46-W32-L150-Z03 |

Helis Pah Frezeleme Takımları / Helix Chamfer Milling Tools

| ° | AHM..-AP16.. | Uç / Insert | Takım Kodu / Tool Code |
|---|--------------|-------------------------|-------------------------------|
| ° | AHM..-AP16.. | AP. 1604.. (For ISO) | AHM15-AP16-D35x93-A27-Z0306-H |
| | | | AHM30-AP16-D35x87-A27-Z0306-H |
| | | | AHM45-AP16-D35x77-A27-Z0306-H |
| | | | AHM60-AP16-D35x65-A22-Z0306-H |
| | | | AHM75-AP16-D35x50-A22-Z0306-H |
| | | | AHM75-AP16-D35x50-A22-Z0306-H |

Vidalalı Takım Tutucular / Screwed Tool Holders

| AVTT | Takım Kodu / Tool Code |
|---|---|
|  | AVTT-D13-C16-M08-L100-H AVTT-D15-C16-M08-L130-H AVTT-D18-C20-M10-L130-H AVTT-D18-C20-M10-L160-H AVTT-D23-C25-M12-L150-H AVTT-D23-C25-M12-L200-H AVTT-D23-C25-M12-L250-H AVTT-D30-C32-M16-L150-H AVTT-D30-C32-M16-L200-H AVTT-D30-C32-M16-L250-H AVTT-D30-C32-M16-L300-H |

S Sistem Yüzey Parmak Frezeler / S System End Mills

| 90° | AEM90-3P.. | Uç / Insert | Takım Kodu / Tool Code |
|---|---------------------------|---|------------------------|
|  | 3P.T 060308 (For TGTC) | AEM90-3P0603-D16-W16-L120-Z03-H AEM90-3P0603-D20-W20-L150-Z03-H AEM90-3P0603-D25-W25-L150-Z05-H | |
| | 3P.T 100408 (For TGTC) | AEM90-3P1004-D20-W20-L150-Z02 AEM90-3P1004-D21-C20-L200-Z02 AEM90-3P1004-D25-W25-L150-Z03 | |
| | 3P.T 150508 (For TGTC) | AEM90-3P1505-D32-W32-L150-Z03 AEM90-3P1505-D38-W32-L150-Z03 AEM90-3P1505-D40-W32-L150-Z04 | |

Yüzey Frezeler / Face Milling Tools

| 90° | AFM90-3P.. | Uç / Insert | Takım Kodu / Tool Code |
|---|---------------------------|---|------------------------|
|  | 3PKT 1004.. | AFM90-3P1004-D040-A16-Z05-H AFM90-3P1004-D050-A22-Z06-H AFM90-3P1505-D050-A22-Z04-H AFM90-3P1505-D050-A22-Z05-H | |
| | 3PKT 1505.. (For TGTC) | AFM90-3P1505-D063-A22-Z04-H AFM90-3P1505-D063-A22-Z06-H AFM90-3P1505-D080-A27-Z07-H AFM90-3P1505-D100-A32-Z08-H AFM90-3P1505-D125-B40-Z10 | |

S Sistem Modüler Parmak Frezeler / S System Modular End Mills (Screw Type Tools)

| 90° | AEM90-3P1004 | Uç / Insert | Takım Kodu / Tool Code |
|---|--------------|--|------------------------|
|  | 3P.T 1004.. | AEM90-3P1004-D20-M10-L35-Z02 AEM90-3P1004-D32-M16-L43-Z05-H | |

S Sistem Yüzey Parmak Frezeler / S System End Mills

| 90° | AEM90-AD.. | Uç / Insert | Takım Kodu / Tool Code |
|---|--------------------------|--|------------------------|
|  | ADMT 1003.. (For DJT) | AEM90-AD1003-D16-C16-L150-Z02 AEM90-AD1003-D17-C16-L150-Z02 AEM90-AD1003-D20-C20-L200-Z03 AEM90-AD1003-D21-C20-L150-Z03 AEM90-AD1003-D21-C20-L200-Z03 AEM90-AD1003-D25-C25-L200-Z03 AEM90-AD1003-D26-C25-L150-Z03 AEM90-AD1003-D26-C25-L200-Z03 | |
| | ADKT 150508 (For DJT) | AEM90-AD1505D-D25-W25-L150-Z02 AEM90-AD1505D-D32-W32-L150-Z03 | |

Yüzey Frezeler / Face Milling Tools

| 90° | AFM90-4N06 | Uç / Insert | Takım Kodu / Tool Code |
|---|---------------------------|--|------------------------|
|  | 4NKT 0603.. (For TGTC) | AFM90-4N06-D040-A16-Z05-H AFM90-4N06-D050-A22-Z06-H | |

S Sistem Yüzey Parmak Frezeler / S System End Mills

| 90° | AEM90-4N06 | Uç / Insert | Takım Kodu / Tool Code |
|--|---------------------------|--|------------------------|
|  | 4NKT 0603.. (For TGTC) | AEM90-4N06-D16-W16-L120-Z02-H AEM90-4N06-D16-W16-L160-Z02 AEM90-4N06-D20-W16-L120-Z03-H AEM90-4N06-D20-W16-L160-Z03 | |

S Sistem Modüler Parmak Frezeler / S System Modular End Mills (Screw Type Tools)

| 90° | AEM90-AD1505D | Uç / Insert | Takım Kodu / Tool Code |
|--|--------------------------|--|------------------------|
|  | ADKT 150508 (For DJT) | AEM90-AD1505D-D25-M12-L43-Z02-H AEM90-AD1505D-D32-M16-L43-Z03-H | |

Yüzey Frezeler / Face Milling Tools

| 90° | AFM90-AD1505D | Uç / Insert | Takım Kodu / Tool Code |
|---|--------------------------|--|------------------------|
|  | ADKT 150508 (For DJT) | AFM90-AD1505D-D050-A22-Z05-H AFM90-AD1505D-D063-A27-Z06-H AFM90-AD1505D-D080-A27-Z08-H AFM90-AD1505D-D100-A32-Z08-H AFM90-AD1505D-D125-B40-Z09 | |

S Sistem Yüzey Parmak Frezeler / S System End Mills

| 90° | AEM90-AD15 | Uç / Insert | Takım Kodu / Tool Code |
|--|---------------------------|---|------------------------|
|  | AD.. 1505.. (For ISCR) | AEM90-AD1505-D25-W25-L150-Z02 AEM90-AD1505-D30-W25-L150-Z03 AEM90-AD1505-D32-W32-L150-Z03 | |

Yüzey Frezeler / Face Milling Tools

| 90° | AFM90-AD1505 | Uç / Insert | Takım Kodu / Tool Code |
|--|---------------------------|--|------------------------|
|  | AD.. 1505.. (For ISCR) | AFM90-AD1505-D040-A16-Z04-H AFM90-AD1505-D050-A22-Z05-H AFM90-AD1505-D063-A22-Z06-H AFM90-AD1505-D080-A27-Z07-H AFM90-AD1505-D100-A32-Z08-H AFM90-AD1505-D125-B40-Z09 | |

S Sistem Yüzey Parmak Frezeler / S System End Mills

| 90° | AEM90-AD.. | Uç / Insert | Takım Kodu / Tool Code |
|--|---------------------------|--|------------------------|
|  | ADMX 0702.. (For PRMT) | AEM90-AD07-D10-C08-L90-Z02-H AEM90-AD07-D10-C10-L80-Z02-H AEM90-AD07-D12-C10-L80-Z03-H AEM90-AD07-D12-C12-L90-Z03-H AEM90-AD07-D16-C16-L110-Z04-H AEM90-AD07-D20-C20-L125-Z05-H AEM90-AD07-D25-C25-L140-Z06-H | |
| | ADMX 11T3.. (For PRMT) | AEM90-AD11-D16-C16-L135-Z02-H AEM90-AD11-D18-C16-L135-Z02-H AEM90-AD11-D18-C16-L160-Z02-H AEM90-AD11-D20-C20-L150-Z02-H AEM90-AD11-D20-C20-L150-Z03-H AEM90-AD11-D22-C20-L150-Z03-H AEM90-AD11-D22-C20-L200-Z03-H AEM90-AD11-D25-C25-L170-Z03-H AEM90-AD11-D25-C25-L170-Z04-H AEM90-AD11-D28-C25-L165-Z04-H AEM90-AD11-D28-C25-L200-Z04-H AEM90-AD11-D30-C25-L165-Z04-H AEM90-AD11-D30-C25-L200-Z04-H AEM90-AD11-D32-C32-L195-Z05-H | |

Frezeleme Takımları / Milling Tools

S Sistem YüzeY Parmak Frezeler / S System End Mills

| 90° | AEM90-AD.. | Uç / Insert | Takım Kodu / Tool Code |
|---|---------------------------|---------------------------------|---------------------------------|
|  | ADMT 0803.. (For WLTR) | | AEM90-AD0803-D16-W16-L150-Z02 |
| | | | AEM90-AD0803-D17-W16-L150-Z02 |
| | | | AEM90-AD0803-D17-W16-L200-Z02 |
| | | | AEM90-AD0803-D20-W20-L150-Z03 |
| | ADMT 10T3.. (For WLTR) | | AEM90-AD0803-D21-W20-L200-Z03 |
| | | | AEM90-AD10T3-D16-W16-L100-Z02-H |
| | | | AEM90-AD10T3-D16-W16-L150-Z02 |
| | | | AEM90-AD10T3-D16-C16-L200-Z02 |
| | | | AEM90-AD10T3-D17-W16-L150-Z02 |
| | | | AEM90-AD10T3-D17-W16-L200-Z02 |
| | | | AEM90-AD10T3-D20-W20-L70-Z03 |
| | | | AEM90-AD10T3-D20-W20-L100-Z03-H |
| ADMT 1204.. (For WLTR) | | AEM90-AD10T3-D20-C20-L150-Z03 | |
| | | AEM90-AD10T3-D20-W20-L150-Z03 | |
| | | AEM90-AD10T3-D20-C20-L200-Z03 | |
| | | AEM90-AD10T3-D25-W25-L100-Z03-H | |
| ADMT 1606.. (For WLTR) | | AEM90-AD10T3-D25-W25-L150-Z03 | |
| | | AEM90-AD1204-D20-W20-L150-Z02 | |
| | | AEM90-AD1204-D21-C20-L150-Z02 | |
| | | AEM90-AD1204-D22-C20-L150-Z02 | |
| | | AEM90-AD1204-D25-W25-L150-Z03 | |
| | | AEM90-AD1204-D26-W25-L180-Z03 | |
| | | AEM90-AD1204-D32-W32-L150-Z04 | |
| | | AEM90-AD1606-D25-W25-L150-Z02 | |
| AEM90-AD1606-D32-W32-L150-Z03 | | | |

YüzeY Frezeler / Face Milling Tools

| 90° | AFM90-AN12 | Uç / Insert | Takım Kodu / Tool Code |
|--|------------|---------------------------|---------------------------|
|  | | ANKX 1205.. (For ISCR) | AFM90-AN12-D040-A16-Z04-H |
| | | | AFM90-AN12-D050-A22-Z05-H |
| | | | AFM90-AN12-D063-A27-Z06-H |

S Sistem YüzeY Parmak Frezeler / S System End Mills

| 90° | AEM90-AN1607 | Uç / Insert | Takım Kodu / Tool Code |
|--|--------------|---------------------------|-------------------------------|
|  | | AN.X 1607.. (For TGTC) | AEM90-AN1607-D32-C25-L150-Z02 |
| | | | AEM90-AN1607-D40-C32-L150-Z03 |

YüzeY Frezeler / Face Milling Tools

| 90° | AFM90-AN1607 | Uç / Insert | Takım Kodu / Tool Code |
|---|--------------|---------------------------|-----------------------------|
|  | | AN.X 1607.. (For TGTC) | AFM90-AN1607-D050-A22-Z04-H |
| | | | AFM90-AN1607-D063-A22-Z06-H |
| | | | AFM90-AN1607-D080-A27-Z07-H |
| | | | AFM90-AN1607-D100-A32-Z08-H |
| | | | AFM90-AN1607-D125-B40-Z10 |

YüzeY Frezeler / Face Milling Tools

| 90° | AFM90-AD10T3 | Uç / Insert | Takım Kodu / Tool Code |
|--|---------------------------|-------------|-----------------------------|
|  | ADMT 10T3.. (For WLTR) | | AFM90-490R08-D063-A22-Z06-H |
| | | | AFM90-490R14-D050-A22-Z04-H |
| | | | AFM90-490R14-D063-A22-Z05-H |
| | | | AFM90-490R14-D080-A27-Z07-H |
| | | | AFM90-490R14-D100-A32-Z07-H |
| | | | AFM90-490R14-D125-B40-Z08 |
| | | | AFM90-490R14-D160-C40-Z12 |
| | | | AFM90-490R14-D200-C60-Z16 |

YüzeY Frezeler / Face Milling Tools

| 90° | AFM90-490R14 | Uç / Insert | Takım Kodu / Tool Code |
|---|--------------|----------------------------|-----------------------------|
|  | | 490R-1404.. (For SNDVK) | AFM90-490R14-D050-A22-Z04-H |
| | | | AFM90-490R14-D063-A22-Z05-H |
| | | | AFM90-490R14-D080-A27-Z07-H |

S Sistem YüzeY Parmak Frezeler / S System End Mills

| 90° | AEM90-AO1236 | Uç / Insert | Takım Kodu / Tool Code |
|--|--------------|-----------------------------|-------------------------------|
|  | | AO.. 1236.. (For MTSBSH) | AEM90-AO1236-D16-W16-L150-Z02 |
| | | | AEM90-AO1236-D20-C20-L100-Z02 |
| | | | AEM90-AO1236-D25-C25-L115-Z02 |
| | | | AEM90-AO1236-D25-W25-L150-Z03 |
| | | | AEM90-AO1236-D32-W32-L150-Z04 |

YüzeY Frezeler / Face Milling Tools

| 90° | AFM90-AN.. | Uç / Insert | Takım Kodu / Tool Code |
|---|------------|--------------------------|-----------------------------|
|  | | ANGX 1105.. | AFM90-AN11-D040-A16-Z04-H |
| | | | AFM90-AN1506-D050-A22-Z04-H |
| | | ANGX 150608 (For ZCC) | AFM90-AN1506-D063-A22-Z05-H |
| | | | AFM90-AN1506-D080-A27-Z06-H |
| | | | AFM90-AN1506-D100-A32-Z08-H |
| | | | AFM90-AN1506-D125-B40-Z12 |
| AFM90-AN1506-D160-C40-Z14 | | | |

S Sistem Modüler Parmak Frezeler / S System Modular End Mills (Screw Type Tools)

| 90° | AEM90-AO1236 | Uç / Insert | Takım Kodu / Tool Code |
|--|--------------|-----------------------------|------------------------------|
|  | | AO.. 1236.. (For MTSBSH) | AEM90-AO1236-D16-M08-L30-Z02 |
| | | | AEM90-AO1236-D20-M10-L35-Z03 |

S Sistem YüzeY Parmak Frezeler / S System End Mills

| 90° | AEM90-AN11 | Uç / Insert | Takım Kodu / Tool Code |
|---|--------------------------|-------------|-----------------------------|
|  | ANGX 110508 (For ZCC) | | AEM90-AN11-D22-W20-L150-Z02 |
| | | | AEM90-AN11-D25-W25-L150-Z02 |
| | | | AEM90-AN11-D25-C25-L200-Z02 |
| | | | AEM90-AN11-D26-W25-L150-Z02 |
| | | | AEM90-AN11-D28-W25-L150-Z02 |
| | | | AEM90-AN11-D32-W32-L150-Z03 |
| | | | AEM90-AN11-D32-C32-L200-Z03 |
| | | | AEM90-AN11-D40-W32-L150-Z04 |

YüzeY Frezeler / Face Milling Tools

| 90° | AFM90-AO.. | Uç / Insert | Takım Kodu / Tool Code |
|--|------------|--|-----------------------------|
|  | | AO.. 1236.. AO.. 1848.. (For MTSBSH) | AFM90-AO1236-D050-A22-Z05-H |
| | | | AFM90-AO1848-D050-A22-Z05-H |
| | | | AFM90-AO1848-D063-A22-Z06-H |

YüzeY Frezeler / Face Milling Tools

S Sistem YüzeY Parmak Frezeler / S System End Mills

| 90° | AEM90-AN1207 | Uç / Insert | Takım Kodu / Tool Code |
|---|------------------------------|-------------|-------------------------------|
|  | ANKX 1207.. (For XTC-GSC) | | AEM90-AN1207-D25-W25-L150-Z02 |
| | | | AEM90-AN1207-D32-W32-L150-Z03 |
| | | | AEM90-AN1207-D40-W32-L150-Z04 |

| 90° | AFM90-AN.. | Uç / Insert | Takım Kodu / Tool Code |
|--|------------------------------|-------------|------------------------------|
|  | ANKX 1207.. (For XTC-GSC) | | AFM90-AN1207-D040-A16-Z04-H |
| | | | AFM90-AN1207-D050-A22-Z05-H |
| | ANKX 1607.. (For XTC-GSC) | | AFM90-AN1207-D063-A22-Z06-H |
| | | | AFM90-AN1607X-D050-A22-Z04-H |
| AFM90-AN1607X-D063-A22-Z06-H | | | |
| AFM90-AN1607X-D080-A27-Z07-H | | | |

S Sistem YüzeY Parmak Frezeler / S System End Mills

| 90° | AEM90-AP.. | Uç / Insert | Takım Kodu / Tool Code | |
|---|---------------------------|-------------------------------|-------------------------------|------------------------------|
|  | APMT 0602.. (For KRLY) | APMT 0602.. (For KRLY) | AEM90-AP06-D10-C10-L120-Z02 | |
| | | | AEM90-AP06-D12-C12-L120-Z02 | |
| | APMT 0903.. (For KRLY) | APMT 0903.. (For KRLY) | AEM90-AP0903-D16-C16-L150-Z02 | |
| | | | AEM90-AP0903-D17-C16-L150-Z02 | |
| | | | AEM90-AP0903-D20-C20-L150-Z02 | |
| | | | AEM90-AP0903-D21-C20-L150-Z02 | |
| | APKT 09T3.. (For TGTC) | APKT 09T3.. (For TGTC) | AEM90-AP09-D16-C16-L100-Z02-H | |
| | | | AEM90-AP09-D16-C15-L150-Z02 | |
| | | | AEM90-AP09-D16-W16-L150-Z02-H | |
| | | | AEM90-AP09-D16-C16-L200-Z02-H | |
| AEM90-AP09-D17-C16-L150-Z02 | | | | |
| AEM90-AP09-D17-C16-L180-Z02-H | | | | |
| AEM90-AP09-D20-C20-L150-Z03-H | | | | |
| AEM90-AP09-D20-C20-L200-Z03-H | | | | |
| AEM90-AP09-D20-C20-L250-Z02-H | | | | |
| AEM90-AP09-D21-C20-L150-Z03 | | | | |
| AP. 1003.. (For ISO) | AP. 1003.. (For ISO) | AEM90-AP10-D12-W16-L100-Z01-H | | |
| | | AEM90-AP10-D12-W16-L150-Z01 | | |
| | | AEM90-AP10-D14-W16-L100-Z01-H | | |
| | | AEM90-AP10-D14-W16-L150-Z01 | | |
| | | AEM90-AP10-D16-C16-L100-Z02-H | | |
| | | AEM90-AP10-D16-C16-L120-Z02-H | | |
| | | AEM90-AP10-D16-C16-L150-Z02 | | |
| | | AEM90-AP10-D16-C16-L150-Z02-H | | |
| | | AEM90-AP10-D16-W16-L150-Z02 | | |
| | | AEM90-AP10-D16-C16-L200-Z02 | | |
| AP. 1003.. (For DJT) | AP. 1003.. (For DJT) | AEM90-AP10-D16-C16-L200-Z02-H | | |
| | | AEM90-AP10-D16-C16-L250-Z02 | | |
| | | AEM90-AP10-D18-W16-L100-Z02-H | | |
| | | AEM90-AP10-D18-W16-L150-Z02 | | |
| | | AEM90-AP10-D20-C20-L100-Z03-H | | |
| | | AEM90-AP10-D20-W20-L100-Z03-H | | |
| | | AEM90-AP10-D20-C20-L120-Z03-H | | |
| | | AEM90-AP10-D20-C20-L150-Z03 | | |
| | | AEM90-AP10-D20-C20-L150-Z03-H | | |
| | | AEM90-AP10-D20-W20-L150-Z03 | | |
| AP. 1003.. (For B.OKE) | AP. 1003.. (For B.OKE) | AEM90-AP10-D20-C20-L200-Z02 | | |
| | | AEM90-AP10-D20-C20-L200-Z03-H | | |
| | | AEM90-AP10-D20-C20-L250-Z02 | | |
| | | AEM90-AP10-D20-C20-L250-Z02-H | | |
| | | AEM90-AP10-D21-W20-L150-Z03 | | |
| | | AEM90-AP10-D22-W20-L100-Z03-H | | |
| | | AEM90-AP10-D22-W20-L150-Z03 | | |
| | | AEM90-AP10-D23-W20-L150-Z03 | | |
| | | AEM90-AP10-D24-W20-L150-Z03 | | |
| | | AEM90-AP10-D25-W25-L100-Z04-H | | |
| AP. 1003.. (For SMTM) | AP. 1003.. (For SMTM) | AEM90-AP10-D25-C25-L100-Z03-H | | |
| | | AEM90-AP10-D25-W25-L100-Z03-H | | |
| | | AEM90-AP10-D25-C25-L120-Z03-H | | |
| | | AEM90-AP10-D25-C25-L150-Z03 | | |
| | | AEM90-AP10-D25-W25-L150-Z03 | | |
| | | AEM90-AP10-D25-C25-L200-Z02 | | |
| | | AEM90-AP10-D25-C25-L200-Z02 | | |
| | | AEM90-AP10-D25-C25-L250-Z02 | | |
| | | AEM90-AP10-D30-C25-L100-Z04-H | | |
| | | AEM90-AP10-D30-C25-L120-Z04-H | | |
| AP. 1003.. (For B.OKE) | AP. 1003.. (For B.OKE) | AEM90-AP10-D30-C25-L150-Z04 | | |
| | | AEM90-AP10-D32-C25-L100-Z04-H | | |
| | | AEM90-AP10-D32-C25-L120-Z04-H | | |
| | | AEM90-AP10-D32-C25-L150-Z04 | | |
| | | AEM90-AP10-D32-W25-L150-Z04 | | |
| | | AEM90-AP10-D32-C32-L130-Z05 | | |
| | | AEM90-AP10-D32-W32-L150-Z04 | | |
| | | AEM90-AP10-D40-W32-L150-Z05 | | |
| | | AP. 1003.. (For DJT) | AP. 1003.. (For DJT) | AEM90-AP10D-D16-W16-L150-Z02 |
| | | | | AEM90-AP10D-D20-W20-L150-Z03 |
| AEM90-AP10D-D25-W20-L150-Z03 | | | | |
| AEM90-AP100-D16-C15-L150-Z02 | | | | |
| AEM90-AP100-D21-C20-L150-Z03 | | | | |
| AEM90-AP100-D26-C25-L150-Z04 | | | | |
| AEM90-AP100-D33-C32-L200-Z05 | | | | |
| AP. 1003.. (For SMTM) | AP. 1003.. (For SMTM) | | | AEM90-AP10S-D16-W16-L150-Z02 |
| | | | | AEM90-AP10S-D20-W20-L150-Z02 |
| | | | | AEM90-AP10S-D25-W25-L150-Z03 |

S Sistem YüzeY Parmak Frezeler / S System End Mills

| 90° | AEM90-AP.. | Uç / Insert | Takım Kodu / Tool Code |
|--|-----------------------------|-----------------------------|---------------------------------|
|  | AP. 11T3.. (For ZCC) | AP. 11T3.. (For ZCC) | AEM90-AP11-D16-C16-L150-Z02 |
| | | | AEM90-AP11-D16-C16-L150-Z02-H |
| | | | AEM90-AP11-D16-W16-L150-Z02 |
| | | | AEM90-AP11-D16-W16-L150-Z02-H |
| | | | AEM90-AP11-D16-C16-L200-Z02 |
| | | | AEM90-AP11-D17-C16-L150-Z02 |
| | | | AEM90-AP11-D17-C16-L200-Z02 |
| | | | AEM90-AP11-D20-C20-L150-Z03 |
| | | | AEM90-AP11-D20-W20-L150-Z03 |
| | | | AEM90-AP11-D20-W20-L150-Z03-H |
| APMT 1135.. (For ACHTK) | APMT 1135.. (For ACHTK) | APMT 1135.. (For ACHTK) | AEM90-AP11-D20-C20-L200-Z03 |
| | | | AEM90-AP11-D21-C20-L150-Z03 |
| | | | AEM90-AP11-D21-W20-L150-Z03 |
| | | | AEM90-AP11-D21-W20-L150-Z03-H |
| | | | AEM90-AP11-D21-C20-L200-Z03 |
| | | | AEM90-AP11-D21-C20-L200-Z03 |
| | | | AEM90-AP11-D25-C25-L150-Z03 |
| | | | AEM90-AP11-D25-W25-L150-Z03 |
| | | | AEM90-AP11-D25-W25-L150-Z03-H |
| | | | AEM90-AP11-D26-C25-L150-Z03 |
| APMT 1135.. (For YG) | APMT 1135.. (For YG) | APMT 1135.. (For YG) | AEM90-AP11-D26-C24-L150-Z03 |
| | | | AEM90-AP11-D32-W25-L150-Z04 |
| | | | AEM90-AP11-D32-W32-L150-Z03-H |
| | | | AEM90-AP11-D32-W32-L150-Z04 |
| | | | AEM90-AP1135A-D14-C16-L150-Z01 |
| | | | AEM90-AP1135A-D16-C16-L150-Z02 |
| | | | AEM90-AP1135A-D16-C16-L200-Z02 |
| | | | AEM90-AP1135A-D16-C16-L250-Z02 |
| | | | AEM90-AP1135A-D17-C16-L180-Z02 |
| | | | AEM90-AP1135A-D20-C20-L150-Z03 |
| APMT 1135.. (For B.OKE) | APMT 1135.. (For B.OKE) | APMT 1135.. (For B.OKE) | AEM90-AP1135A-D20-C20-L200-Z02 |
| | | | AEM90-AP1135A-D21-C20-L180-Z02 |
| | | | AEM90-AP1135A-D25-C25-L200-Z03 |
| | | | AEM90-AP1135A-D26-C25-L250-Z02 |
| | | | AEM90-AP1135A-D33-C32-L250-Z02 |
| | | | AEM90-AP1135Y-D16-W16-L150-Z02 |
| | | | AEM90-AP1135Y-D20-W20-L150-Z03 |
| | | | AEM90-AP1135Y-D25-W25-L150-Z03 |
| | | | AEM90-AP110-D16-C15-L150-Z02 |
| | | | AEM90-AP110-D21-C20-L150-Z03 |
| AP. 1135.. (For XTC-GSC) | AP. 1135.. (For XTC-GSC) | AP. 1135.. (For XTC-GSC) | AEM90-AP110-D26-C25-L150-Z04 |
| | | | AEM90-AP110-D33-C32-L200-Z05 |
| | | | AEM90-APK11G-D16-W16-L150-Z02 |
| | | | AEM90-APK11G-D20-W20-L150-Z03 |
| | | | AEM90-APK11G-D25-W25-L150-Z03 |
| | | | AEM90-AP1135-D16-W16-L110-Z02-H |
| | | | AEM90-AP1135-D16-W16-L150-Z02 |
| | | | AEM90-AP1135-D20-W20-L125-Z03-H |
| | | | AEM90-AP1135-D20-W20-L150-Z03 |
| | | | AEM90-AP1135-D25-W25-L125-Z04-H |
| AP. 1204.. (For TGTC) | AP. 1204.. (For TGTC) | AP. 1204.. (For TGTC) | AEM90-AP1135-D25-W25-L200-Z04-H |
| | | | AEM90-AP1135-D32-W32-L125-Z05-H |
| | | | AEM90-AP1135-D32-W32-L200-Z04-H |
| | | | AEM90-AP1204-D20-C20-L150-Z02 |
| | | | AEM90-AP1204-D21-C20-L150-Z02 |
| | | | AEM90-AP1204-D21-C20-L200-Z02 |
| | | | AEM90-AP1204-D25-C25-L150-Z03 |
| | | | AEM90-AP1204-D26-C25-L250-Z02 |
| | | | AEM90-AP1204-D32-C25-L150-Z03 |
| | | | AEM90-AP16-D25-C20-L100-Z02 |
| AP. 1604.. (For ISO) | AP. 1604.. (For ISO) | AP. 1604.. (For ISO) | AEM90-AP16-D25-W25-L100-Z02-H |
| | | | AEM90-AP16-D25-W25-L150-Z02 |
| | | | AEM90-AP16-D25-C25-L250-Z02 |
| | | | AEM90-AP16-D28-W25-L100-Z03-H |
| | | | AEM90-AP16-D28-W25-L150-Z03 |
| | | | AEM90-AP16-D30-W25-L110-Z03-H |
| | | | AEM90-AP16-D30-W25-L150-Z02 |
| | | | AEM90-AP16-D30-W25-L150-Z03 |
| | | | AEM90-AP16-D32-W32-L110-Z03-H |
| | | | AEM90-AP16-D32-W32-L150-Z03 |
| AEM90-AP16-D32-W32-L150-Z03 | | | |
| AEM90-AP16-D32-W32-L150-Z03-H | | | |
| AEM90-AP16-D32-C25-L200-Z03-H | | | |
| AEM90-AP16-D32-C32-L250-Z02 | | | |
| AEM90-AP16-D32-C32-L250-Z03 | | | |

Frezeleme Takımları / Milling Tools

S Sistem Yüzey Parmak Frezeler / S System End Mills

| 90° | AEM90-AP.. | Uç / Insert | Takım Kodu / Tool Code |
|-----|------------|--------------------------|--|
| | | AP. 1604.. (For ISO) | AEM90-AP16-D35-W32-L150-Z03 AEM90-AP16-D36-W32-L110-Z03-H AEM90-AP16-D36-W32-L150-Z03 AEM90-AP16-D40-W32-L110-Z04-H AEM90-AP16-D40-C32-L150-Z04 AEM90-AP16-D40-W32-L150-Z04 AEM90-AP16-D40-C32-L250-Z02 AEM90-AP16-D40-C32-L250-Z04 |
| | | AP. 1604.. (For DJT) | AEM90-AP16DJ-D25-W25-L150-Z02 AEM90-AP16DJ-D25-C25-L200-Z02 AEM90-AP16DJ-D32-W32-L150-Z03 AEM90-AP16DJ-D32-C32-L180-Z03 AEM90-AP16DJ-D32-C32-L200-Z03 |
| | | AP. 1604.. (For LMN) | AEM90-AP16L-D25-C25-L120-Z02-H AEM90-AP16L-D25-C25-L150-Z02 AEM90-AP16L-D25-C25-L200-Z02 AEM90-AP16L-D25-C25-L250-Z02 AEM90-AP16L-D32-C32-L120-Z03-H AEM90-AP16L-D32-C32-L150-Z03 AEM90-AP16L-D32-C32-L200-Z03 AEM90-AP16L-D32-C32-L250-Z03 AEM90-AP16L-D40-C32-L120-Z04-H AEM90-AP16L-D40-C32-L150-Z04 AEM90-AP16L-D40-C32-L200-Z04 AEM90-AP16L-D40-C32-L250-Z04 |
| | | AP. 1604.. (For PLBT) | AEM90-AP16P-D25-W25-L100-Z02-H AEM90-AP16P-D25-W25-L150-Z02 AEM90-AP16P-D32-W32-L150-Z03 AEM90-AP16P-D32-C32-L250-Z02 AEM90-AP16P-D40-W32-L150-Z04 |
| | | AP. 1705.. (For TGTC) | AEM90-AP1705-D25-C25-L120-Z02 AEM90-AP1705-D26-C25-L200-Z02 AEM90-AP1705-D26-C25-L250-Z02 AEM90-AP1705-D26-C25-L300-Z02 AEM90-AP1705-D28-W25-L075-Z02 AEM90-AP1705-D32-C25-L150-Z03 AEM90-AP1705-D32-C32-L250-Z03 AEM90-AP1705-D32-C32-L300-Z02 |



S Sistem Helis Frezeler / S System Helix End Mills

| 90° | AHM90-AP1204 | Uç / Insert | Takım Kodu / Tool Code |
|-----|--------------|--------------------------|--|
| | | AP. 1204.. (For TGTC) | AHM90-AP1204-D32-W32-L140-Z0212-H AHM90-AP1204-D40-W32-L160-Z0321-H |



Yüzey Frezeler / Face Milling Tools

| 75° | AFM75-AP16 | Uç / Insert | Takım Kodu / Tool Code |
|-----|------------|-------------------------|--|
| | | AP. 1604.. (For ISO) | AFM75-AP16-D063-A22-Z04-H AFM75-AP16-D080-A27-Z05-H AFM75-AP16-D100-A32-Z06-H AFM75-AP16-D125-B40-Z07 |



Yüzey Frezeler / Face Milling Tools

| 90° | AFM90-AP.. | Uç / Insert | Takım Kodu / Tool Code |
|-----|------------|---------------------------|--|
| | | AP. 1003.. (For ISO) | AFM90-AP10-D040-A16-Z05-H AFM90-AP10-D050-A22-Z06-H AFM90-AP10-D063-A22-Z07-H AFM90-AP10-D080-A27-Z08-H AFM90-AP10-D100-A32-Z09-H AFM90-AP16-D040-A16-Z04-H AFM90-AP16-D050-A22-Z05-H AFM90-AP16-D052-A22-Z05-H AFM90-AP16-D063-A22-Z06-H AFM90-AP16-D080-A27-Z07-H AFM90-AP16-D100-A32-Z08-H AFM90-AP16-D125-B40-Z09 AFM90-AP16-D160-C40-Z10 AFM90-AP16-D200-C60-Z12 |
| | | AP. 1604.. (For ISO) | AFM90-AP16D-D050-A22-Z05-H AFM90-AP16D-D063-A22-Z06-H AFM90-AP16D-D080-A27-Z07-H |
| | | AP. 1604.. (For LMNA) | AFM90-AP16L-D050-A22-Z05-H AFM90-AP16L-D063-A22-Z06-H AFM90-AP16L-D080-A27-Z07-H |
| | | AP. 1604.. (For PLBT) | AFM90-AP16P-D040-A16-Z04-H AFM90-AP16P-D050-A22-Z05-H AFM90-AP16P-D063-A22-Z06-H AFM90-AP16P-D080-A27-Z07-H AFM90-AP16P-D100-A32-Z08-H AFM90-AP16A-D050-A22-Z05-H AFM90-AP16A-D063-A22-Z06-H AFM90-AP16A-D080-A27-Z07-H AFM90-AP16A-D100-A32-Z08-H AFM90-AP16A-D125-B40-Z09 AFM90-AP16Y-D040-A16-Z04-H AFM90-AP16Y-D050-A22-Z05-H AFM90-AP16Y-D063-A22-Z06-H AFM90-AP16Y-D080-A27-Z07-H AFM90-AP16Y-D100-A32-Z08-H |
| | | AP. 1604.. (For ACHTK) | |
| | | AP. 1604.. (For YG) | |



Yüzey Frezeler / Face Milling Tools

| 90° | AFM90-AP1705 | Uç / Insert | Takım Kodu / Tool Code |
|-----|--------------|-------------------------------|--|
| | | AP. 1705.. (For TGTC-LMNA) | AFM90-AP1705-D050-A22-Z05-H AFM90-AP1705-D063-A22-Z06-H AFM90-AP1705-D080-A27-Z07-H AFM90-AP1705-D100-A32-Z08-H |



S Sistem Modüler Parmak Frezeler / S System Modular End Mills (Screw Type Tools)

| 90° | AEM90-AP.. | Uç / Insert | Takım Kodu / Tool Code |
|-----|------------|--------------------------|--|
| | | AP. 1003.. (For ISO) | AEM90-AP10-D16-M08-L30-Z02-H AEM90-AP10-D20-M10-L30-Z03-H AEM90-AP10-D25-M12-L35-Z03-H AEM90-AP10-D32-M16-L35-Z04-H AEM90-AP10-D40-M16-L43-Z05-H AEM90-AP10-D42-M16-L43-Z05-H |
| | | AP. 1003.. (For DJT) | AEM90-AP10D-D16-M08-L30-Z02-H AEM90-AP10D-D20-M10-L30-Z03-H AEM90-AP10D-D25-M12-L35-Z03-H |
| | | AP. 11T3.. (For ZCC) | AEM90-AP11-D16-M08-L30-Z02-H AEM90-AP11-D20-M10-L30-Z03-H AEM90-AP11-D25-M12-L35-Z03-H AEM90-AP11-D32-M16-L35-Z04-H AEM90-AP11-D40-M16-L43-Z05-H |
| | | AP. 1604.. (For ISO) | AEM90-AP16-D25-M12-L43-Z02-H AEM90-AP16-D32-M16-L43-Z03-H AEM90-AP16-D40-M16-L43-Z04-H AEM90-AP16-D42-M16-L43-Z04-H |
| | | AP. 1604.. (For DJT) | AEM90-AP16D-D25-M12-L43-Z02-H AEM90-AP16D-D32-M16-L43-Z03-H AEM90-AP16D-D40-M16-L43-Z04-H |
| | | AP. 1604.. (For LMNA) | AEM90-AP16L-D25-M12-L43-Z02-H AEM90-AP16L-D32-M16-L43-Z03-H AEM90-AP16L-D40-M16-L43-Z04-H |



S Sistem Helis Frezeler / S System Helix End Mills

| 90° | AHM90-AP10 | Uç / Insert | Takım Kodu / Tool Code |
|-----|------------|-------------------------|---|
| | | AP. 1003.. (For ISO) | AHM90-AP10-D20-W20-L087-Z0204 AHM90-AP10-D20-W20-L087-Z0206 AHM90-AP10-D25-W25-L105-Z0208-H AHM90-AP10-D32-W32-L115-Z0315-H AHM90-AP10-D40-W32-L130-Z0318-H |



S Sistem Modüler Parmak Frezeler / S System Modular End Mills (Screw Type Tools)

| 90° | AEM90-AX.. | Uç / Insert | Takım Kodu / Tool Code |
|-----|------------|---------------------------|--|
| | | AX.T 1235.. (For SMTM) | AEM90-AX1235-D16-M08-L30-Z02-H AEM90-AX1235-D20-M10-L30-Z03-H AEM90-AX1235-D25-M12-L35-Z04-H |
| | | AX.T 1705.. (For SMTM) | AEM90-AX1705-D25-M12-L43-Z02-H AEM90-AX1705-D32-M16-L43-Z02-H |



S Sistem YüzeY Parmak Frezeler / S System End Mills

| 90° | AEM90-AX.. | Uç / Insert | Takım Kodu / Tool Code |
|---|---------------------------------|-------------|---------------------------------|
|  | AX.T 0602.. (For TGTC) | | AEM90-AX0602-D10-C09-L120-Z02 |
| | | | AEM90-AX0602-D10-C10-L080-Z02 |
| | | | AEM90-AX0602-D10-C10-L120-Z02 |
| | | | AEM90-AX0602-D12-C11-L120-Z02 |
| | | | AEM90-AX0602-D12-C12-L080-Z02 |
| | | | AEM90-AX0602-D12-C12-L120-Z02 |
| | | | AEM90-AX0602-D14-C12-L120-Z03 |
| | | | AEM90-AX0602-D16-W16-L120-Z04-H |
| | | | AEM90-AX0602-D16-W16-L150-Z04-H |
| | | | AEM90-AX0602-D20-W20-L120-Z05-H |
| | AEM90-AX0602-D20-W20-L150-Z05-H | | |
| | AX.T 0903.. (For TGTC) | | AEM90-AX0903-D16-C16-L120-Z02 |
| | | | AEM90-AX0903-D16-C16-L180-Z02 |
| | | | AEM90-AX0903-D17-C16-L120-Z02 |
| | | | AEM90-AX0903-D17-C16-L180-Z02 |
| | | | AEM90-AX0903-D20-C20-L120-Z03 |
| | | | AEM90-AX0903-D20-C20-L200-Z03 |
| | | | AEM90-AX0903-D21-C20-L120-Z03 |
| AEM90-AX0903-D21-C20-L200-Z02 | | | |
| AEM90-AX0903-D25-C25-L150-Z03 | | | |
| AEM90-AX0903-D25-C25-L250-Z02 | | | |
| AEM90-AX0903-D26-C25-L150-Z03 | | | |

S Sistem YüzeY Parmak Frezeler / S System End Mills

| 90° | AEM90-AZ11.. | Uç / Insert | Takım Kodu / Tool Code |
|--|--------------------------|-------------|-----------------------------|
|  | AZGT 1135.. (For ZCC) | | AEM90-AZ11-D12-W16-L90-Z01 |
| | | | AEM90-AZ11-D16-C16-L200-Z02 |
| | | | AEM90-AZ11-D16-W15-L170-Z02 |
| | | | AEM90-AZ11-D16-W16-L100-Z02 |
| | | | AEM90-AZ11-D16-W16-L150-Z02 |
| | | | AEM90-AZ11-D17-C16-L150-Z02 |
| | | | AEM90-AZ11-D17-C16-L180-Z02 |
| | | | AEM90-AZ11-D17-W16-L100-Z02 |
| | | | AEM90-AZ11-D18-W16-L120-Z02 |
| | | | AEM90-AZ11-D20-C20-L200-Z03 |
| | | | AEM90-AZ11-D20-W19-L170-Z03 |
| | | | AEM90-AZ11-D20-W20-L110-Z02 |
| | | | AEM90-AZ11-D21-C20-L150-Z03 |
| | | | AEM90-AZ11-D21-C20-L180-Z03 |
| | | | AEM90-AZ11-D21-W20-L110-Z03 |
| | | | AEM90-AZ11-D22-C20-L150-Z02 |
| | | | AEM90-AZ11-D25-C24-L180-Z04 |
| | | | AEM90-AZ11-D25-W25-L110-Z04 |
| | | | AEM90-AZ11-D26-C25-L250-Z02 |
| | | | AEM90-AZ11-D26-W25-L120-Z03 |
| | | | AEM90-AZ11-D26-W25-L120-Z04 |
| | | | AEM90-AZ11-D28-C25-L180-Z03 |
| | | | AEM90-AZ11-D28-C25-L250-Z02 |
| | | | AEM90-AZ11-D33-W32-L130-Z04 |

S Sistem YüzeY Parmak Frezeler / S System End Mills

| 90° | AEM90-AX.. | Uç / Insert | Takım Kodu / Tool Code |
|---|---------------------------|-------------|---------------------------------|
|  | AX.T 1235.. (For SMTM) | | AEM90-AX1235-D16-C14-L120-Z02-H |
| | | | AEM90-AX1235-D16-C15-L145-Z02-H |
| | | | AEM90-AX1235-D16-C16-L100-Z02-H |
| | | | AEM90-AX1235-D16-C16-L140-Z02-H |
| | | | AEM90-AX1235-D16-C16-L145-Z02-H |
| | | | AEM90-AX1235-D16-C16-L150-Z02 |
| | | | AEM90-AX1235-D20-C19-L150-Z02-H |
| | | | AEM90-AX1235-D20-C20-L110-Z03-H |
| | | | AEM90-AX1235-D20-C20-L150-Z02 |
| | | | AEM90-AX1235-D20-C20-L150-Z02-H |
| | | | AEM90-AX1235-D20-C20-L150-Z03 |
| | | | AEM90-AX1235-D25-C20-L120-Z04-H |
| | | | AEM90-AX1235-D25-C20-L150-Z04-H |
| | | | AEM90-AX1235-D25-C24-L170-Z02-H |
| | | | AEM90-AX1235-D25-C25-L120-Z04-H |
| | | | AEM90-AX1235-D25-C25-L150-Z03 |
| | | | AEM90-AX1235-D25-C25-L170-Z02-H |
| | | | AEM90-AX1235-D25-W25-L100-Z04-H |
| | | | AEM90-AX1235-D32-C32-L130-Z05-H |
| | | | AEM90-AX1235-D32-C32-L180-Z02-H |
| | AX.T 1705.. (For SMTM) | | AEM90-AX1705-D25-C25-L150-Z02 |
| | | | AEM90-AX1705-D28-W25-L115-Z02-H |
| | | | AEM90-AX1705-D32-C32-L150-Z03 |
| | | | AEM90-AX1705-D32-C32-L180-Z02-H |

S Sistem YüzeY Parmak Frezeler / S System End Mills

| 90° | AEM90-BD.. | Uç / Insert | Takım Kodu / Tool Code |
|--|---------------------------------|---------------------------------|---------------------------------|
|  | BDMT 11T3.. (For KYCR) | | AEM90-BD11T3-D16-C15-L180-Z02 |
| | | | AEM90-BD11T3-D16-C16-L100-Z02-H |
| | | | AEM90-BD11T3-D16-W16-L100-Z02-H |
| | | | AEM90-BD11T3-D16-W16-L150-Z02 |
| | | | AEM90-BD11T3-D16-C16-L160-Z02-H |
| | | | AEM90-BD11T3-D17-W16-L150-Z02 |
| | | | AEM90-BD11T3-D17-C16-L180-Z02 |
| | | | AEM90-BD11T3-D18-W16-L100-Z02 |
| | | | AEM90-BD11T3-D18-W16-L100-Z02-H |
| | | | AEM90-BD11T3-D20-C20-L170-Z03-H |
| | | | AEM90-BD11T3-D20-W20-L81-Z03-H |
| | | | AEM90-BD11T3-D20-W20-L100-Z02-H |
| | | | AEM90-BD11T3-D20-W20-L100-Z03-H |
| | | | AEM90-BD11T3-D20-C20-L110-Z03-H |
| | | | AEM90-BD11T3-D25-C20-L120-Z03-H |
| | | | AEM90-BD11T3-D20-W20-L150-Z02 |
| | | | AEM90-BD11T3-D20-W20-L150-Z03 |
| | | | AEM90-BD11T3-D20-W20-L150-Z03-H |
| | | | AEM90-BD11T3-D21-W20-L150-Z03 |
| | | | AEM90-BD11T3-D21-C20-L200-Z02 |
| | | | AEM90-BD11T3-D22-W20-L090-Z02-H |
| | | | AEM90-BD11T3-D25-W25-L100-Z03-H |
| | | | AEM90-BD11T3-D25-C25-L120-Z03-H |
| | | | AEM90-BD11T3-D25-W25-L150-Z03 |
| | | | AEM90-BD11T3-D26-W25-L150-Z03 |
| | | | AEM90-BD11T3-D26-C25-L250-Z02 |
| | | | AEM90-BD11T3-D32-W32-L110-Z04-H |
| | | | AEM90-BD11T3-D32-C32-L130-Z04-H |
| | AEM90-BD11T3-D32-W32-L150-Z04 | | |
| | AEM90-BD11T3-D40-W32-L110-Z04-H | | |
| AEM90-BD11T3-D40-W32-L110-Z04-H | | | |
| AEM90-BD1704.. (For KYCR) | | AEM90-BD1704-D25-C25-L210-Z03-H | |
| AEM90-BD1704-D32-C32-L130-Z03-H | | | |
| AEM90-BD1704-D25-W25-L100-Z02-H | | AEM90-BD1704-D25-W25-L150-Z02 | |
| AEM90-BD1704-D32-W32-L110-Z03-H | | AEM90-BD1704-D32-W32-L130-Z03-H | |
| AEM90-BD1704-D32-W32-L150-Z03 | | AEM90-BD1704-D40-W32-L110-Z04-H | |
| AEM90-BD1704-D40-W32-L150-Z04 | | | |

YüzeY Frezeler / Face Milling Tools

| 90° | AFM90-AX1705 | Uç / Insert | Takım Kodu / Tool Code |
|---|---------------------------|-------------|-----------------------------|
|  | AX.T 1235.. (For SMTM) | | AFM90-AX1235-D040-A16-Z06-H |
| | | | AFM90-AX1235-D050-A22-Z07-H |
| | | | AFM90-AX1235-D063-A22-Z08-H |
| | | | AFM90-AX1235-D080-A27-Z10-H |
| | | | AFM90-AX1705-D040-A16-Z04-H |
| | AX.T 1705.. (For SMTM) | | AFM90-AX1705-D050-A22-Z05-H |
| | | | AFM90-AX1705-D063-A22-Z06-H |
| | | | AFM90-AX1705-D080-A27-Z07-H |
| | | | AFM90-AX1705-D100-A32-Z08-H |
| | | | |

S Sistem Modüler Parmak Frezeler / S System Modular End Mills (Screw Type Tools)

| 90° | AEM90-BD11T3 | Uç / Insert | Takım Kodu / Tool Code |
|--|---------------------------|-------------|--------------------------------|
|  | BDMT 11T3.. (For KYCR) | | AEM90-BD11T3-D16-M08-L25-Z02-H |
| | | | AEM90-BD11T3-D25-M12-L35-Z04-H |
| | | | AEM90-BD11T3-D32-M16-L40-Z05-H |

Frezeleme Takımları / Milling Tools

Yüzey Frezeler / Face Milling Tools

| 90° | AFM90-BD.. | Uç / Insert | Takım Kodu / Tool Code |
|---|------------|---------------------------|--|
|  | | BDMT 11T3.. (For KYCR) | AFM90-BD11T3-D040-A16-Z04-H AFM90-BD11T3-D040-A16-Z05-H AFM90-BD11T3-D050-A22-Z05-H AFM90-BD11T3-D063-A22-Z06-H |
| | | BDMT 1704.. (For KYCR) | AFM90-BD1704-D050-A22-Z04-H AFM90-BD1704-D050-A22-Z05-H AFM90-BD1704-D063-A22-Z06-H AFM90-BD1704-D080-A27-Z06-H AFM90-BD1704-D080-A27-Z07-H AFM90-BD1704-D100-A32-Z07-H |

S Sistem Modüler Parmak Frezeler / S System Modular End Mills (Screw Type Tools)

| 90° | AEM90-DC.. | Uç / Insert | Takım Kodu / Tool Code |
|---|------------|--------------------------|--|
|  | | DC.T 0702. (For ISO) | AEM90-DC07-D20-M10-L30-Z02-H AEM90-DC07-D25-M12-L35-Z03-H AEM90-DC07-D32-M16-L43-Z04-H AEM90-DC07-D40-M16-L43-Z05-H |
| | | DC.T 11T3.. (For ISO) | AEM90-DC11-D32-M16-L43-Z03-H-F AEM90-DC11-D40-M16-L43-Z03-H-F |

S Sistem Yüzey Parmak Frezeler / S System End Mills

| 90° | AEM90-ED.. | Uç / Insert | Takım Kodu / Tool Code |
|---|------------|----------------------------|---|
|  | | EDPT 10T3.. (For KNMTL) | AEM90-ED10T3-D16-W16-L120-Z02 AEM90-ED10T3-D20-W20-L120-Z02 |
| | | EDPT 1404.. (For KNMTL) | AEM90-ED1404-D20-W20-L150-Z02 AEM90-ED1404-D25-W25-L150-Z02 AEM90-ED1404-D30-C25-L150-Z03 |

Yüzey Frezeler / Face Milling Tools

| 45° | AFM45-HN0905 | Uç / Insert | Takım Kodu / Tool Code |
|---|--------------|--------------------------|--|
|  | | HN.. 0905.. (For WDA) | AFM45-HN0905-D050-A22-Z05-H AFM45-HN0905-D063-A22-Z06-H AFM45-HN0905-D080-A27-Z07-H AFM45L-HN0905-D100-A32-Z08-H AFM45-HN0905-D125-B40-Z10 AFM45L-HN0905-D125-B40-Z10 AFM45-HN0905-D160-C40-Z12 AFM45L-HN0905-D160-C40-Z12 AFM45-HN0905-D200-C60-Z16 AFM45L-HN0905-D200-C60-Z16 |

Yüzey Frezeler / Face Milling Tools

| 45° | AFM45C-HN0905 | Uç / Insert | Takım Kodu / Tool Code |
|---|---------------|--------------------------------|---|
|  | | HN.. 0905.. (For WDA-KNMTL) | AFM45C-HN0905-D063-A22-Z07 AFM45C-HN0905-D080-A27-Z09 AFM45C-HN0905-D100-A32-Z11 AFM45C-HN0905-D125-B40-Z13 AFM45CL-HN0905-D125-B40-Z10 AFM45C-HN0905-D160-C40-Z15 |

Yüzey Frezeler / Face Milling Tools

| 90° | AFM90-LN1306W | Uç / Insert | Takım Kodu / Tool Code |
|---|---------------|---------------------------|--|
|  | | LNHU 1306.. (For WLTR) | AFM90-LN1306W-D050-A22-Z05-H AFM90-LN1306W-D063-A22-Z06-H AFM90-LN1306W-D080-A27-Z07-H |

S Sistem Yüzey Parmak Frezeler / S System End Mills

| 90° | AEM90-LN.. | Uç / Insert | Takım Kodu / Tool Code |
|--|------------|-----------------------------------|---|
|  | | LNMT 0804.. (For ISCR) | AEM90-LN08-D16-W16-L100-Z02-H AEM90-LN08-D16-W16-L150-Z02 AEM90-LN08-D20-W20-L100-Z03-H AEM90-LN08-D25-W25-L100-Z03-H AEM90-LN08-D32-W32-L110-Z05-H |
| | | T490 LNMT 1306.. (For ISCR) | AEM90-LN1306-D32-C32-L110-Z03-H AEM90-LN1306-D32-W32-L150-Z03 |

Yüzey Frezeler / Face Milling Tools

| 90° | AFM90-LN.. | Uç / Insert | Takım Kodu / Tool Code |
|---|------------|-----------------------------------|--|
|  | | LNMT 1106.. (For ISCR) | AFM90-LN1106-D050-A22-Z05 AFM90-LN1106-D063-A22-Z06 AFM90-LN1106-D080-A27-Z08 AFM90-LN1106-D100-A32-Z09 AFM90-LN1106-D100-A32-Z09 AFM90-LN1106-D125-B40-Z10 |
| | | T490 LNMT 1306.. (For ISCR) | AFM90-LN1306-D040-A16-Z04-H AFM90-LN1306-D050-A22-Z05-H AFM90-LN1306-D063-A22-Z06-H AFM90-LN1306-D080-A27-Z07-H AFM90-LN1306-D100-A32-Z08-H |
| | | LNMT 1506.. (For ISCR) | AFM90L-LN1506-D040-A16-Z04 AFM90-LN1506-D040-A16-Z04 AFM90-LN1506-D050-A22-Z05 AFM90-LN1506-D063-A22-Z06 AFM90-LN1506-D080-A27-Z07 |
| | | LNMT 1607.. (For ISCR) | AFM90-LN1607-D050-A22-Z03-H AFM90-LN1607-D063-A22-Z04-H AFM90-LN1607-D080-A27-Z05-H AFM90-LN1607-D100-A32-Z06-H |

S Sistem Yüzey Parmak Frezeler / S System End Mills

| 90° | AEM90-LN1106 | Uç / Insert | Takım Kodu / Tool Code |
|--|--------------|------------------------------|---|
|  | | LNMT 1106.. (For XTC-GSC) | AEM90-LN1106-D25-W25-L150-Z03 AEM90-LN1106-D32-W32-L150-Z04 AEM90-LN1106-D40-W32-L150-Z05 |

Yüzey Frezeler / Face Milling Tools

| 90° | AFM90-LN1506X | Uç / Insert | Takım Kodu / Tool Code |
|--|---------------|------------------------------|--|
|  | | LNMT 1506.. (For XTC-GSC) | AFM90-LN1506X-D063-A22-Z06 AFM90-LN1506X-D080-A27-Z07 AFM90-LN1506X-D100-A32-Z08 |

Yüzey Frezeler / Face Milling Tools

| 90° | AFM90-L01207 | Uç / Insert | Takım Kodu / Tool Code |
|--|--------------|-----------------------------|---|
|  | | LOGU 1207.. (For MTSBSH) | AFM90-L01207-D040-A16-Z04-H AFM90-L01207-D050-A22-Z05-H AFM90-L01207-D063-A22-Z05-H |

Yüze Frezeler / Face Milling Tools

| 90° | AFM90-L008 | Uç / Insert | Takım Kodu / Tool Code |
|---|-------------------|-------------------------|---|
|  | | LOEX 0804.. (For SC) | AFM90-L008-D040-A16-Z06-H AFM90-L008-D050-A22-Z07-H AFM90-L008-D063-A27-Z06-H |

| 45° | AFM45-NN2007 | Uç / Insert | Takım Kodu / Tool Code |
|---|---------------------|-----------------------------|---|
|  | | NNMU 2007.. (For MTSBSH) | AFM45-NN2007-D100-A32-Z07-H AFM45-NN2007-D125-B40-Z08 AFM45-NN2007-D160-C40-Z10 |

S Sistem Yüze Parmak Frezeler / S System End Mills

| 90° | AEM90-LN15T6 | Uç / Insert | Takım Kodu / Tool Code |
|---|---------------------|----------------------------|---|
|  | | LNGU 15T6.. (For KNMTL) | AEM90-LN15T6-D25-W25-L150-Z02-H AEM90-LN15T6-D32-W32-L150-Z03-H AEM90-LN15T6-D40-W32-L150-Z03-H |

Yüze Frezeler / Face Milling Tools

| 90° | AFM90-LN15T6 | Uç / Insert | Takım Kodu / Tool Code |
|---|---------------------|----------------------------|---|
|  | | LNGU 15T6.. (For KNMTL) | AFM90-LN15T6-D050-A22-Z05-H AFM90-LN15T6-D063-A22-Z06-H AFM90-LN15T6-D080-A27-Z07-H |

S Sistem Yüze Parmak Frezeler / S System End Mills

| 90° | AEM90-LN1006 | Uç / Insert | Takım Kodu / Tool Code |
|---|---------------------|---------------------------|---|
|  | | LN.X 1006.. (For KRLY) | AEM90-LN1006-D16-W16-L120-Z01-H AEM90-LN1006-D16-W16-L150-Z01 AEM90-LN1006-D18-W16-L120-Z02-H AEM90-LN1006-D20-W20-L120-Z02-H AEM90-LN1006-D20-W20-L150-Z02 AEM90-LN1006-D25-W25-L120-Z03-H AEM90-LN1006-D25-W25-L150-Z03 AEM90-LN1006-D32-W32-L120-Z04-H AEM90-LN1006-D32-W32-L150-Z04 |

Yüze Frezeler / Face Milling Tools

| 90° | AFM90-LN1307 | Uç / Insert | Takım Kodu / Tool Code |
|---|---------------------|---------------------------|--|
|  | | LNGX 1307.. (For WLTR) | AFM90-LN1307-D050-A22-Z04-H AFM90-LN1307-D063-A22-Z06-H AFM90-LN1307-D080-A27-Z07-H AFM90-LN1307-D100-A32-Z08-H |

Yüze Frezeler / Face Milling Tools

| 90° | AFM90-LN15Z | Uç / Insert | Takım Kodu / Tool Code |
|---|--------------------|--------------------------|--|
|  | | LNKT 1506.. (For ZCC) | AFM90-LN15Z-D050-A22-Z04 AFM90-LN15Z-D063-A22-Z05 AFM90-LN15Z-D080-A27-Z06 AFM90-LN15Z-D100-A32-Z07 AFM90-LN15Z-D125-B40-Z08 |

Yüze Frezeler / Face Milling Tools

| 43° | AFM43-OD0504 | Uç / Insert | Takım Kodu / Tool Code |
|---|---------------------|---------------------------|---|
|  | | OD.. 0504.. (For WLTR) | AFM43-OD0504-D040-A16-Z04-H AFM43-OD0504-D050-A22-Z05-H AFM43-OD0504-D063-A22-Z06-H AFM43-OD0504-D080-A27-Z07-H AFM43-OD0504-D100-A32-Z08-H |

Yüze Frezeler / Face Milling Tools

| 43° | AFM43C-OD0605 | Uç / Insert | Takım Kodu / Tool Code |
|--|----------------------|--------------------------------|--|
|  | | OD.. 0605.. (For WLTR-LMNA) | AFM43C-OD0605-D080-A27-Z06-H AFM43C-OD0605-D100-A32-Z07-H AFM43C-OD0605-D125-B40-Z08 |

Yüze Frezeler / Face Milling Tools

| 43° | AFM43-OF05T3 | Uç / Insert | Takım Kodu / Tool Code |
|--|---------------------|--------------------------|--|
|  | | OF.. 05T3.. (For ISO) | AFM43-OF05T3-D050-A22-Z05-H AFM43-OF05T3-D063-A22-Z06-H AFM43-OF05T3-D080-A27-Z07-H AFM43-OF05T3-D125-B40-Z09 |

Yüze Frezeler / Face Milling Tools

| 43° | AFM43C-OF07 | Uç / Insert | Takım Kodu / Tool Code |
|---|--------------------|--------------------------|--|
|  | | OF.. 0704.. (For ISO) | AFM43C-OF07-D063-A22-Z04 AFM43C-OF07-D080-A27-Z05 AFM43C-OF07-D100-A32-Z06 AFM43C-OF07-D125-B40-Z08 AFM43C-OF07-D160-C40-Z09 |

Yüze Frezeler / Face Milling Tools

| 43° | AFM43-ON0604 | Uç / Insert | Takım Kodu / Tool Code |
|--|---------------------|--------------------------|---|
|  | | ON.. 0604.. (For ZCC) | AFM43-ON0604-D050-A22-Z05-H AFM43-ON0604-D063-A22-Z06-H AFM43-ON0604-D080-A27-Z07-H AFM43-ON0604-D100-A32-Z08-H AFM43-ON0604-D125-B40-Z09 |

Yüze Frezeler / Face Milling Tools

| 45° | AFM45-ON0806 | Uç / Insert | Takım Kodu / Tool Code |
|--|---------------------|--------------------------|--|
|  | | ON.. 0806.. (For ISO) | AFM45-ON0806-D063-A22-Z05-H AFM45-ON0806-D063-A22-Z06-H AFM45-ON0806-D080-A27-Z06-H AFM45-ON0806-D080-A27-Z08-H AFM45-ON0806-D100-A32-Z07-H AFM45-ON0806-D100-A32-Z10-H AFM45-ON0806-D125-B40-Z08 AFM45-ON0806-D100-A32-Z10 AFM45-ON0806-D160-C40-Z10 AFM45-ON0806-D125-B40-Z12 AFM45-ON0806-D200-C60-Z12 AFM45-ON0806-D160-C40-Z14 AFM45-ON0806-D250-C60-Z14 AFM45-ON0806-D315-D60-Z16 AFM45C-ON0806-D080-A27-Z10 AFM45C-ON0806-D100-A32-Z14-H AFM45C-ON0806-D125-B40-Z18 AFM45C-ON0806-D160-C40-Z22 |

Yüze Frezeler / Face Milling Tools

| 44° | AFM44-ON0606 | Uç / Insert | Takım Kodu / Tool Code |
|--|---------------------|---------------------------|---|
|  | | ONHX 0606.. (For KRLY) | AFM44-ON0606-D063-A22-Z06-H AFM44-ON0606-D080-A27-Z08-H AFM44-ON0606-D100-A32-Z10-H |

Frezeleme Takımları / Milling Tools

Yüze Frezeler / Face Milling Tools

| 66° | AFM66-PN0905 | Uç / Insert | Takım Kodu / Tool Code |
|---|--------------|---------------------------|---|
|  | | PNMU 0905.. (For KYCR) | AFM66-PN0905-D050-A22-Z05 AFM66-PN0905-D063-A22-Z06 AFM66-PN0905-D080-A27-Z08 AFM66-PN0905-D100-A32-Z10 AFM66-PN0905-D125-B40-Z12 |

S Sistem Modüler Parmak Frezeler / S System Modular End Mills (Screw Type Tools)

| 90° | AEM90-RT10 | Uç / Insert | Takım Kodu / Tool Code |
|--|------------|-------------------------|--|
|  | | RT 1003.. (For SFTY) | AEM90-RT10-D16-M08-L20-Z02-H AEM90-RT10-D20-M10-L25-Z03-H AEM90-RT10-D25-M12-L30-Z04-H AEM90-RT10-D32-M16-L43-Z05-H AEM90-RT10-D42-M16-L43-Z06-H |

Yüze Frezeler / Face Milling Tools

| 67° | AFM67-PN1105 | Uç / Insert | Takım Kodu / Tool Code |
|---|--------------|--------------------------|--|
|  | | PNEG 1105.. (For ZCC) | AFM67-PN1105-D050-A22-Z05 AFM67-PN1105-D063-A22-Z06 AFM67-PN1105-D080-A27-Z08 AFM67-PN1105-D100-B32-Z10 AFM67-PN1105-D125-B40-Z12 AFM67-PN1105-D160-C40-Z14 |

Yüze Frezeler / Face Milling Tools

| 90° | AFM90-R390.. | Uç / Insert | Takım Kodu / Tool Code |
|--|--------------|----------------------------|--|
|  | | R390-11T3.. (For SNDVK) | AFM90-R390.11-D040-A16-Z05-H AFM90-R390.11-D050-A22-Z06-H AFM90-R390.11-D063-A22-Z07-H AFM90-R390.11-D080-A27-Z09-H |
| | | R390-1704.. (For SNDVK) | AFM90-R390.17-D040-A16-Z04-H AFM90-R390.17-D050-A22-Z05-H AFM90-R390.17-D063-A22-Z06-H AFM90-R390.17-D080-A27-Z07-H AFM90-R390.17-D100-A32-Z08-H AFM90-R390.17-D125-B40-Z09 |
| | | R390-1806.. (For SNDVK) | AFM90-R390.18-D050-A22-Z04-H AFM90-R390.18-D063-A22-Z05-H AFM90-R390.18-D080-A27-Z06-H AFM90-R390.18-D100-A32-Z07-H AFM90-R390.18-D125-B40-Z08 |

Yüze Frezeler / Face Milling Tools

| 90° | AFM90-R290.12 | Uç / Insert | Takım Kodu / Tool Code |
|--|---------------|----------------------------|--|
|  | | R290-12T3.. (For SNDVK) | AFM90-R290.12-D050-A22-Z04-H AFM90-R290.12-D063-A22-Z05-H AFM90-R290.12-D080-A27-Z07-H AFM90-R290.12-D100-A32-Z09-H AFM90-R290.12-D125-B40-Z11 |

S Sistem Yüze Parmak Frezeler / S System End Mills

| 90° | AEM90-RT.. | Uç / Insert | Takım Kodu / Tool Code |
|--|------------|-------------------------|--|
|  | | RT 0702.. (For SFTY) | AEM90-RT07-D10-W10-L120-Z02 AEM90-RT07-D12-C12-L120-Z02 AEM90-RT07-D12-W12-L120-Z02 AEM90-RT07-D14-W12-L120-Z02 |
| | | RT 1003.. (For SFTY) | AEM90-RT10-D16-C15-L160-Z02 AEM90-RT10-D16-W16-L120-Z02-H AEM90-RT10-D16-W16-L150-Z02 AEM90-RT10-D16-C16-L200-Z02 AEM90-RT10-D17-W16-L160-Z02 AEM90-RT10-D17-C16-L200-Z02 AEM90-RT10-D18-W16-L120-Z02-H AEM90-RT10-D20-C19-L200-Z03 AEM90-RT10-D20-C20-L110-Z03 AEM90-RT10-D20-W20-L120-Z03-H AEM90-RT10-D20-W20-L150-Z03 AEM90-RT10-D20-C20-L200-Z03 AEM90-RT10-D21-W20-L200-Z03 AEM90-RT10-D22-W20-L120-Z03-H AEM90-RT10-D22-C20-L150-Z03 AEM90-RT10-D22-C20-L200-Z03 AEM90-RT10-D25-W25-L120-Z04-H AEM90-RT10-D25-W25-L150-Z04 AEM90-RT10-D25-C25-L200-Z04 AEM90-RT10-D26-C25-L250-Z04 AEM90-RT10-D32-W32-L120-Z05-H AEM90-RT10-D32-W32-L150-Z05 AEM90-RT10-D32-C32-L200-Z05 AEM90-RT10-D33-C32-L250-Z04 |
| | | RT 1304.. (For SFTY) | AEM90-RT13-D32-C32-L250-Z04 |

S Sistem Yüze Parmak Frezeler / S System End Mills

| 90° | AEM90-R390.. | Uç / Insert | Takım Kodu / Tool Code |
|---|--------------|----------------------------|--|
|  | | R390-11T3.. (For SNDVK) | AEM90-R390.11-D16-W16-L100-Z02-H AEM90-R390.11-D16-W16-L150-Z02 AEM90-R390.11-D16-W16-L150-Z02-H AEM90-R390.11-D20-W20-L090-Z02-H AEM90-R390.11-D20-W20-L100-Z03-H AEM90-R390.11-D20-W20-L150-Z03 AEM90-R390.11-D20-W20-L150-Z03-H AEM90-R390.11-D20-C20-L150-Z03 AEM90-R390.11-D22-W20-L090-Z02-H AEM90-R390.11-D25-C20-L150-Z03 AEM90-R390.11-D25-W25-L100-Z03-H AEM90-R390.11-D25-W25-L150-Z03 AEM90-R390.11-D25-W25-L150-Z03-H AEM90-R390.11-D30-W25-L150-Z04-H AEM90-R390.11-D32-C25-L200-Z03 AEM90-R390.11-D32-W32-L150-Z05-H |
| | | R390-1704.. (For SNDVK) | AEM90-R390.17-D25-W25-L150-Z02 AEM90-R390.17-D25-W25-L150-Z03 AEM90-R390.17-D30-W25-L150-Z03 AEM90-R390.17-D30-W25-L150-Z03-H AEM90-R390.17-D32-W32-L150-Z03-H |
| | | R390-1806.. | AEM90-R390.18-D32-C32-L150-Z03 |

S Sistem Modüler Parmak Frezeler / S System Modular End Mills (Screw Type Tools)

| 90° | AEM90-R390.11 | Uç / Insert | Takım Kodu / Tool Code |
|---|---------------|--------------------------|--|
|  | | R390-11T3 (For SNDVK) | AEM90-R390.11-D16-M08-L30-Z02-H AEM90-R390.11-D20-M10-L30-Z03-H AEM90-R390.11-D25-M12-L35-Z03-H AEM90-R390.11-D32-M16-L43-Z04-H |

| 90° | AEM90-R390.11 | Uç / Insert | Takım Kodu / Tool Code |
|-----|---------------|-------------------------|---|
| | | RT 1604.. (For SFTY) | AEM90-RT16-D25-W25-L120-Z02-H AEM90-RT16-D25-W25-L150-Z02 AEM90-RT16-D25-C25-L200-Z02 AEM90-RT16-D32-W32-L120-Z03-H AEM90-RT16-D32-W32-L150-Z03 AEM90-RT16-D32-C32-L200-Z03 AEM90-RT16-D32-C32-L250-Z03 AEM90-RT16-D32-C32-L270-Z03 AEM90-RT16-D40-W32-L120-Z04-H AEM90-RT16-D40-W32-L150-Z04 AEM90-RT16-D40-C32-L200-Z04 |

Yüze Frezeler / Face Milling Tools

| 90° | AFM90-RT10 | Uç / Insert | Takım Kodu / Tool Code |
|---|------------|-------------------------|---|
|  | | RT 1003.. (For SFTY) | AFM90-RT10-D040-A16-Z06-H AFM90-RT10-D050-A22-Z07-H AFM90-RT10-D063-A22-Z09-H |

Yüze Frezeler / Face Milling Tools

| 45° | AFM45-SE13 | Uç / Insert | Takım Kodu / Tool Code |
|--|------------|-------------------------------|---|
|  | | SEMT 13T3.. (For SMTM-DJT) | AFM45-SE13-D050-A22-Z04-H AFM45-SE13-D063-A22-Z05-H AFM45-SE13-D080-A27-Z06-H AFM45S-SE13-D050-A22-Z05-H AFM45S-SE13-D063-A22-Z06-H AFM45S-SE13-D080-A27-Z08-H AFM45S-SE13-D100-A32-Z10-H AFM45S-SE13-D125-B40-Z12 |

Yüze Frezeler / Face Milling Tools

| 45° | AFM45-SA1706 | Uç / Insert | Takım Kodu / Tool Code |
|---|--------------|----------------------------|---|
|  | | SAKU 1706.. (For CRTZT) | AFM45-SA1706-D080-A27-Z06-H AFM45-SA1706-D100-A32-Z07-H AFM45-SA1706-D125-B40-Z09 |

Yüze Frezeler / Face Milling Tools

| 90° | AEM90-S0803 | Uç / Insert | Takım Kodu / Tool Code |
|--|-------------|---------------------------|---|
|  | | SOMT 0803.. (For SMTM) | AEM90-S00803-D20-C16-L110-Z02-H AEM90-S00803-D25-C20-L110-Z02-H AEM90-S00803-D32-C25-L120-Z03-H |

Yüze Frezeler / Face Milling Tools

| 90° | AFM90-SD.. | Uç / Insert | Takım Kodu / Tool Code |
|--|------------|---------------------------|--|
|  | | SD.. 09M4.. (For KRLY) | AFM90-SD09M4-D040-A16-Z04-H AFM90-SD09M4-D050-A22-Z05-H AFM90-SD09M4-D063-A22-Z06-H AFM90-SD09M4-D063-A27-Z06-H AFM90-SD09M4-D080-A27-Z07-H |
| | | SD.. 1305.. (For KRLY) | AFM90-SD1305-D050-A22-Z04-H AFM90-SD1305-D063-A22-Z05-H AFM90-SD1305-D080-A27-Z06-H AFM90-SD1305-D100-A32-Z07-H AFM90-SD1305-D125-B40-Z08 AFM90-SD1305-D160-C40-Z10 |

Yüze Frezeler / Face Milling Tools

| 45° | AFM45-SE.. | Uç / Insert | Takım Kodu / Tool Code |
|--|------------|--|---|
|  | | SE.. 12T3..- R245-12T3.. (For ZCC-SNDVK) | AFM45-SE12-D050-A22-Z04-H AFM45L-SE12-D050-A22-Z04-H AFM45-SE12-D063-A22-Z05-H AFM45L-SE12-D063-A22-Z05-H AFM45-SE12-D080-A27-Z06-H AFM45L-SE12-D080-A27-Z06-H AFM45-SE12-D100-A32-Z07-H AFM45-SE12-D125-B40-Z08 AFM45-SE12-D160-C40-Z10 AFM45L-SE12-D160-C40-Z10 AFM45-SE12-D200-C60-Z12 |
| | | SE.. 14M4.. (For KRLY) | AFM45-SE14M4-D063-A22-Z04-H AFM45-SE14M4-D080-A27-Z05-H AFM45-SE14M4-D100-A32-Z05-H AFM45-SE14M4-D125-B40-Z06 AFM45-SE14M4-D160-C40-Z07 |

Yüze Frezeler / Face Milling Tools

| 90° | AFM90S-SD1204 | Uç / Insert | Takım Kodu / Tool Code |
|---|---------------|--------------------------|--|
|  | | SDMT 1204.. (For DJT) | AFM90S-SD1204-D050-A22-Z04-H AFM90S-SD1204-D063-A22-Z05-H AFM90S-SD1204-D080-A27-Z06-H AFM90S-SD1204-D100-A32-Z08-H AFM90S-SD1204-D125-B40-Z10 AFM90S-SD1204-D160-C40-Z12 |

Yüze Frezeler / Face Milling Tools

| 90° | AFM90-SE12 | Uç / Insert | Takım Kodu / Tool Code |
|--|------------|--------------------------|---|
|  | | SEET 1203.. (For ZCC) | AFM90-SE12-D050 A22 Z04-H AFM90-SE12-D063 A22 Z05-H AFM90-SE12-D080 A27 Z07-H AFM90-SE12-D100 A32 Z09-H AFM90-SE12-D125 B40 Z11 |

S Sistem Yüze Parmak Frezeler / S System End Mills

| 90° | AEM90-SE09 | Uç / Insert | Takım Kodu / Tool Code |
|---|------------|--------------------------|--|
|  | | SEET 09T3.. (For ZCC) | AEM90-SE09-D25-C25-L120-Z03-H AEM90-SE09-D25-C25-L150-Z02 AEM90-SE09-D32-C32-L120-Z04-H AEM90-SE09-D32-C32-L150-Z03 |

Yüze Frezeler / Face Milling Tools

| 45° | AFM45C-SN1206 | Uç / Insert | Takım Kodu / Tool Code |
|--|---------------|---|--|
|  | | SN.. 1206.. (For KRLY- PLBT-BHLR) | AFM45C-SN1206-D050-A22-Z04-H AFM45C-SN1206-D050-A22-Z05-H AFM45CL-SN1206-D050-A22-Z05-H AFM45C-SN1206-D063-A22-Z06-H AFM45C-SN1206-D063-A22-Z07-H AFM45CL-SN1206-D063-A22-Z07-H AFM45C-SN1206-D080-A27-Z07-H AFM45C-SN1206-D080-A27-Z08-H AFM45CL-SN1206-D080-A27-Z08-H AFM45C-SN1206-D100-A32-Z10-H AFM45CL-SN1206-D100-A32-Z10-H AFM45C-SN1206-D125-B40-Z11 AFM45CL-SN1206-D125-B40-Z11 AFM45C-SN1206-D160-C40-Z12 AFM45C-SN1206-D200-C60-Z14 AFM45CL-SN1206-D200-C60-Z14 |

Yüze Frezeler / Face Milling Tools

| 90° | AFM90-SE09 | Uç / Insert | Takım Kodu / Tool Code |
|---|------------|--------------------------|---|
|  | | SEET 09T3.. (For ZCC) | AFM90-SE09-D040-A16-Z04-H AFM90-SE09-D050-A22-Z05-H AFM90-SE09-D063-A22-Z06-H |

Frezeleme Takımları / Milling Tools

Yüzey Frezeler / Face Milling Tools

| 45° | AFM45C-SN.. | Uç / Insert | Takım Kodu / Tool Code |
|---|-------------|------------------------------------|-------------------------------|
|  | | SN.. 12... (For WLTR-LMN-ACHTK) | AFM45C-SN12..-D050-A22-Z04-H |
| | | | AFM45C-SN12..-D050-A22-Z05-H |
| | | | AFM45C-SN12..-D063-A22-Z06-H |
| | | | AFM45C-SN12..-D063-A22-Z07-H |
| | | | AFM45CL-SN12..-D063-A22-Z07-H |
| | | | AFM45C-SN12..-D080-A27-Z07-H |
| | | | AFM45C-SN12..-D080-A27-Z08-H |
| | | | AFM45CL-SN12..-D080-A27-Z08-H |
| | | | AFM45C-SN12..-D100-A32-Z08-H |
| | | | AFM45C-SN12..-D100-A32-Z10-H |
| | | | AFM45CL-SN12..-D100-A32-Z10-H |
| | | | AFM45C-SN12..-D125-B40-Z11 |
| | | | AFM45CL-SN12..-D125-B40-Z11 |
| | | | AFM45C-SN12..-D160-C40-Z12 |
| | | | AFM45C-SN12..-D200-C60-Z14 |
| AFM45CL-SN12..-D200-C60-Z14 | | | |

Yüzey Frezeler / Face Milling Tools

| 88° | AFM88-SN1305 | Uç / Insert | Takım Kodu / Tool Code |
|--|--------------|---------------------------|---------------------------|
|  | | SNMU 1305.. (For KYCR) | AFM88-SN1305-D050-A22-Z04 |
| | | | AFM88-SN1305-D050-A22-Z05 |
| | | | AFM88-SN1305-D063-A22-Z05 |
| | | | AFM88-SN1305-D063-A22-Z07 |
| | | | AFM88-SN1305-D080-A27-Z06 |
| | | | AFM88-SN1305-D080-A27-Z09 |
| | | | AFM88-SN1305-D100-A32-Z07 |
| | | | AFM88-SN1305-D100-A32-Z11 |
| | | | AFM88-SN1305-D125-B40-Z13 |
| | | | |

Yüzey Frezeler / Face Milling Tools

| 88° | AFM88C-SN1204 | Uç / Insert | Takım Kodu / Tool Code |
|---|---------------|------------------------------------|----------------------------|
|  | | SNCN 1204.. (For UNIN-NT..KYCR) | AFM88C-SN1204-D050-A22-Z05 |
| | | | AFM88C-SN1204-D063-A22-Z06 |
| | | | AFM88C-SN1204-D080-A27-Z07 |
| | | | AFM88C-SN1204-D100-A32-Z08 |
| | | | AFM88C-SN1204-D125-B40-Z11 |

Yüzey Frezeler / Face Milling Tools

| 88° | AFM88C-SN1206 | Uç / Insert | Takım Kodu / Tool Code |
|---|---------------|--------------------------|------------------------------|
|  | | SN.. 1206.. (For ISO) | AFM88C-SN1206-D063-A22-Z06-H |
| | | | AFM88C-SN1206-D080-A27-Z07-H |
| | | | AFM88C-SN1206-D100-A32-Z09-H |
| | | SN.. 12.. (For ISO) | AFM88C-SN12..-D063-A22-Z06-H |
| | | | AFM88C-SN12..-D080-A27-Z07-H |
| | | | AFM88C-SN12..-D100-A32-Z09-H |

Yüzey Frezeler / Face Milling Tools

| 45° | AFM45C-SN12Z | Uç / Insert | Takım Kodu / Tool Code |
|---|--------------|--------------------------|-----------------------------|
|  | | SNEG 1205.. (For ZCC) | AFM45C-SN12Z-D050-A22-Z05-H |
| | | | AFM45C-SN12Z-D063-A22-Z06-H |
| | | | AFM45C-SN12Z-D080-A27-Z07-H |
| | | | AFM45C-SN12Z-D100-A32-Z09-H |
| | | | AFM45C-SN12Z-D125-B40-Z11 |
| | | | AFM45C-SN12Z-D160-C40-Z12 |
| | | | AFM45C-SN12Z-D200-C60-Z14 |

Yüzey Frezeler / Face Milling Tools

| 88° | AFM88C-SN12Z | Uç / Insert | Takım Kodu / Tool Code |
|--|--------------|--------------------------|-----------------------------|
|  | | SNEG 1205.. (For ZCC) | AFM88C-SN12Z-D063-A22-Z06-H |
| | | | AFM88C-SN12Z-D080-A27-Z07-H |

Yüzey Frezeler / Face Milling Tools

| 90° | AFM90-SP09T3 | Uç / Insert | Takım Kodu / Tool Code |
|--|--------------|----------------------------|-----------------------------|
|  | | SPMT 09T3.. (For SNDVK) | AFM90-SP09T3-D040-A16-Z05-H |
| | | | AFM90-SP09T3-D050-A22-Z06-H |
| | | | AFM90-SP09T3-D063-A22-Z07-H |
| | | | AFM90-SP09T3-D080-A27-Z08-H |

| 90° | AFM90-SP1004 | Uç / Insert | Takım Kodu / Tool Code |
|--|--------------|--|-----------------------------|
|  | | SPMT 1004.. XPMR 1004.. QPMR 1004.. QPMT 1004.. (For ISCR) | AFM90-SP1004-D040-A16-Z04-H |
| | | | AFM90-SP1004-D050-A22-Z04-H |
| | | | AFM90-SP1004-D050-A22-Z06-H |
| | | | AFM90-SP1004-D063-A22-Z05-H |
| | | | AFM90-SP1004-D080-A27-Z07-H |
| AFM90-SP1004-D100-A32-Z08-H | | | |

S Sistem Yüzey Parmak Frezeler / S System End Mills

| 90° | AEM90-SPGT | Uç / Insert | Takım Kodu / Tool Code | |
|--|------------|--------------------------|---------------------------------|---------------------------------|
|  | | SPGT 0602.. (For ZCC) | AEM90-SPGT0602-D16-W16-L150-Z02 | |
| | | | SPGT 07T3.. (For ZCC) | AEM90-SPGT07T3-D20-W20-L150-Z03 |
| | | | SPGT 07T3.. (For ZCC) | AEM90-SPGT07T3-D25-W25-L150-Z03 |
| | | | SPGT 0904.. (For ZCC) | AEM90-SPGT0904-D30-W32-L150-Z03 |

Yüzey Frezeler / Face Milling Tools

| 75° | AFM75C-SP12 | Uç / Insert | Takım Kodu / Tool Code |
|--|-------------|--------------------------|--------------------------|
|  | | SPKN 1203.. (For ISO) | AFM75C-SP12-D050-A22-Z04 |
| | | | AFM75C-SP12-D063-A22-Z05 |
| | | | AFM75C-SP12-D080-A27-Z06 |
| | | | AFM75C-SP12-D100-A32-Z07 |
| | | | AFM75C-SP12-D125-B40-Z08 |
| | | | AFM75C-SP12-D160-C40-Z09 |
| | | | AFM75C-SP12-D200-C60-Z12 |
| | | | |

Yüzey Frezeler / Face Milling Tools

| 88° | AFM88-SN1306 | Uç / Insert | Takım Kodu / Tool Code |
|--|--------------|---------------------------|-----------------------------|
|  | | SNGX 1306.. (For TGTC) | AFM88-SN1306-D050-A22-Z05-H |
| | | | AFM88-SN1306-D063-A22-Z06-H |
| | | | AFM88-SN1306-D080-A27-Z07-H |

Yüzey Frezeler / Face Milling Tools

| 89° | AFM89-SN1305I | Uç / Insert | Takım Kodu / Tool Code |
|--|---------------|---|------------------------------|
|  | | SNMU 1305.. SNMU 1305.. OXMT 0705.. (For ISCR) | AFM89-SN1305I-D040-A16-Z04-H |
| | | | AFM89-SN1305I-D050-A22-Z05-H |
| | | | AFM89-SN1305I-D063-A22-Z06-H |
| | | | AFM89-SN1305I-D063-A22-Z07-H |
| | | | AFM89-SN1305I-D080-A27-Z08-H |
| | | | AFM89-SN1305I-D100-A32-Z10-H |

S Sistem YüzeY Parmak Frezeler / S System End Mills

| 90° | AEM90-TNG10 | Uç / Insert | Takım Kodu / Tool Code |
|---|-------------|--------------------------|--|
|  | | TNGX 1004. (For PRMT) | AEM90-TNG10-D20-C20-L125-Z02-H AEM90-TNG10-D20-C20-L125-Z03-H AEM90-TNG10-D20-C20-L150-Z03-H AEM90-TNG10-D21-C20-L200-Z03-H AEM90-TNG10-D25-C25-L150-Z03-H AEM90-TNG10-D25-C25-L150-Z04-H AEM90-TNG10-D25-C25-L170-Z04-H AEM90-TNG10-D26-C25-L250-Z04-H AEM90-TNG10-D32-C32-L170-Z04-H AEM90-TNG10-D32-C32-L170-Z05-H AEM90-TNG10-D33-C32-L250-Z05-H |

| 90° | AEM90-VC2205 | Uç / Insert | Takım Kodu / Tool Code |
|---|--------------|--------------------------|--|
|  | | VCKT 2205.. (For ISO) | AEM90-VC2205-D32-C25-L150-Z02-H AEM90-VC2205-D40-C32-L150-Z03-H |

YüzeY Frezeler / Face Milling Tools

| 90° | AFM90C-TP.. | Uç / Insert | Takım Kodu / Tool Code |
|--|-------------|------------------------|--|
|  | | TP.. 1603 (For ISO) | AFM90C-TP16-D050-A22-Z04 AFM90C-TP16-D063-A22-Z06 AFM90C-TP16-D080-A27-Z07 AFM90C-TP16-D100-A32-Z08 AFM90C-TP16-D125-B40-Z08 AFM90C-TP22-D063-A22-Z05 AFM90C-TP22-D080-A27-Z06 AFM90C-TP22-D100-A32-Z07 AFM90C-TP22-D125-B40-Z08 AFM90C-TP22-D160-C40-Z09 AFM90C-TP22-D200-C60-Z12 AFM90C-TP22-D250-C60-Z15 AFM90C-TP22-D315-D60-Z18 |
| | | TP.. 2204 (For ISO) | |

YüzeY Frezeler / Face Milling Tools

| 90° | AFM90-TN2207 | Uç / Insert | Takım Kodu / Tool Code |
|---|--------------|---------------------------|--|
|  | | TN.X 2207.. (For TGTC) | AFM90-TN2207-D063-A22-Z04-H AFM90-TN2207-D080-A27-Z05-H AFM90-TN2207-D100-B32-Z06 AFM90-TN2207-D125-B40-Z08 |

YüzeY Frezeler / Face Milling Tools

| 90° | AFM90-VC2205 | Uç / Insert | Takım Kodu / Tool Code |
|---|--------------|--------------------------|--|
|  | | VCKT 2205.. (For ISO) | AFM90-VC2205-D050-A22-Z03-H AFM90-VC2205-D063-A22-Z04-H AFM90-VC2205-D066-A27-Z04-H AFM90-VC2205-D080-A27-Z05-H |

S Sistem YüzeY Parmak Frezeler / S System End Mills

| 90° | AEM90-WNG04.. | Uç / Insert | Takım Kodu / Tool Code |
|---|---------------|-------------------------------|---|
|  | | WNGU 0403... (For XTC GSC) | AEM90-WNG04-D20-W20-L81-Z03-H AEM90-WNG04-D20-C20-L170-Z03-H AEM90-WNG04-D25-W25-L88-Z03-H AEM90-WNG04-D25-W25-L88-Z04-H AEM90-WNG04-D25-C25-L170-Z03-H AEM90-WNG04-D32-W25-L100-Z05-H AEM90-WNG04-D32-W32-L100-Z05-H AEM90-WNG04-D32-C25-L170-Z04-H AEM90-WNG04-D32-C32-L170-Z04-H |
| | | WNGU 0806.. (For XTC GSC) | AEM90-WNG08-D40-W32-L100-Z03-H AEM90-WNG08-D40-C32-L170-Z03-H |

YüzeY Frezeler / Face Milling Tools

| 90° | AFM90-WNG | Uç / Insert | Takım Kodu / Tool Code |
|--|-----------|------------------------------|--|
|  | | WNGU 0403.. (For XTC-GSC) | AFM90-WNG04-D040-A16-Z06-H AFM90-WNG04-D050-A22-Z05-H AFM90-WNG04-D050-A22-Z07-H AFM90-WNG04-D063-A22-Z06-H |
| | | WNGU 0806.. (For XTC-GSC) | AFM90-WNG08-D050-A22-Z05-H AFM90-WNG08-D063-A22-Z06-H AFM90-WNG08-D080-A27-Z07-H |

YüzeY Frezeler / Face Milling Tools

| 90° | AFM90-TP2205 | Uç / Insert | Takım Kodu / Tool Code |
|--|--------------|---------------------------|--|
|  | | TPKT 2205.. (For TGTC) | AFM90-TP2205-D063-A22-Z04 AFM90-TP2205-D080-A27-Z06 AFM90-TP2205-D100-A32-Z07 AFM90-TP2205-D125-B40-Z08 AFM90-TP2205-D160-C40-Z09 AFM90-TP2205-D200-C60-Z12 |

YüzeY Frezeler / Face Milling Tools

| 90° | AFM90-WN0806 | Uç / Insert | Takım Kodu / Tool Code |
|---|--------------|------------------------------|---|
|  | | WNMX 080608 (For KYCR-JD) | AFM90-WN0806-D050-A16-Z04-H AFM90-WN0806-D063-A22-Z05-H AFM90-WN0806-D080-A27-Z07-H |

S Sistem Modüler Parmak Frezeler / S System Modular End Mills (Screw Type Tools)

| 90° | AEM90-WN0604Z | Uç / Insert | Takım Kodu / Tool Code |
|--|---------------|--------------------------|---|
|  | | WNHU 0604.. (For ZCC) | AEM90-WN0604Z-D25-M12-L35-Z02-H AEM90-WN0604Z-D32-M16-L43-Z03-H AEM90-WN0604Z-D40-M16-L43-Z04-H |

S Sistem YüzeY Parmak Frezeler / S System End Mills

| 90° | AEM90-WN0604Z | Uç / Insert | Takım Kodu / Tool Code |
|--|---------------|--------------------------|--|
|  | | WNHU 0604.. (For ZCC) | AEM90-WN0604Z-D25-W25-L150-Z02-H AEM90-WN0604Z-D32-W32-L150-Z03-H AEM90-WN0604Z-D40-W32-L150-Z04-H |

YüzeY Frezeler / Face Milling Tools

| 90° | AFM90-WN.. | Uç / Insert | Takım Kodu / Tool Code |
|--|------------|--------------------------|--|
|  | | WNHU 0604.. (For ZCC) | AFM90-WN0604Z-D040-A16-Z04-H AFM90-WN0604Z-D050-A22-Z05-H AFM90-WN0604Z-D063-A22-Z06-H AFM90-WN0604Z-D080-A27-Z07-H AFM90-WN0604Z-D100-A32-Z09-H AFM90-WN0806Z-D050-A22-Z04-H AFM90-WN0806Z-D063-A22-Z05-H AFM90-WN0806Z-D080-A27-Z06-H AFM90-WN0806Z-D100-A32-Z08-H AFM90-WN0806Z-D125-B40-Z10 AFM90-WN0806Z-D160-C40-Z12 |
| | | WNHU 0806.. (For ZCC) | |

S Sistem YüzeY Parmak Frezeler / S System End Mills

| 90° | AEM90-XC13 | Uç / Insert | Takım Kodu / Tool Code |
|--|------------|-------------------------|---|
|  | | XCXK 13T3.. (For SC) | AEM90-XC13-D20-W20-L150-Z02 AEM90-XC13-D25-W25-L150-Z03 AEM90-XC13-D32-W32-L150-Z04 |

Frezeleme Takımları / Milling Tools

S Sistem Modüler Parmak Frezeler / S System Modular End Mills (Screw Type Tools)

| 95° | AEM95-XD.. | Uç / Insert | Takım Kodu / Tool Code |
|---|------------|--------------------------|--|
|  | | XDHW 0206.. (For DJT) | AEM95-XD0206-D16-M08-L23-Z02-H AEM95-XD0206-D16-M08-L23-Z02-H-F AEM95-XD0206-D20-M10-L30-Z03-H AEM95-XD0206-D20-M10-L30-Z03-H-F AEM95-XD0206-D25-M12-L35-Z03-H AEM95-XD0206-D25-M12-L35-Z03-H-F |
| | | XDHW 0310.. (For DJT) | AEM95C-XD0310-D35-M16-L43-Z03-H AEM95C-XD0310-D35-M16-L43-Z03-H-F AEM95C-XD0310-D42-M16-L43-Z04-H AEM95C-XD0310-D42-M16-L43-Z04-H-F |

S Sistem YüzeY Parmak Frezeler / S System End Mills

| 90° | AEM90-XO.. | Uç / Insert | Takım Kodu / Tool Code |
|--|------------|-------------------------|--|
|  | | XO.. 0602.. (For SC) | AEM90-XO06-D10-C12-L120-Z02 AEM90-XO06-D12-C12-L120-Z02 |
| | | XO.. 0903.. (For SC) | AEM90-XO09-D16-W16-L150-Z02 AEM90-XO09-D20-W20-L150-Z03 AEM90-XO12-D20-W20-L150-Z02 AEM90-XO12-D20-C20-L200-Z02 AEM90-XO12-D22-W20-L150-Z02 AEM90-XO12-D25-W25-L150-Z03 AEM90-XO12-D25-C25-L200-Z03 AEM90-XO12-D32-C25-L150-Z04 AEM90-XO12-D32-W32-L150-Z04 AEM90-XO12-D32-C32-L250-Z04 |

S Sistem YüzeY Parmak Frezeler / S System End Mills

| 90° | AEM90-XN.. | Uç / Insert | Takım Kodu / Tool Code |
|---|------------|-------------------------|--|
|  | | XNEX 0403.. (For SC) | AEM90-XN0403-D16-C16-L100-Z01-H AEM90-XN0403-D22-C20-L110-Z03-H |
| | | XNEX 0806.. (For SC) | AEM90-XN0806-D32-C32-L110-Z02-H |

YüzeY Frezeler / Face Milling Tools

| 90° | AFM90-X012 | Uç / Insert | Takım Kodu / Tool Code |
|--|------------|-------------------------|---|
|  | | XO.. 1204.. (For SC) | AFM90-X012-D040-A16-Z05-H AFM90-X012-D050-A22-Z07-H AFM90-X012-D063-A22-Z08-H AFM90-X012-D080-A27-Z10-H AFM90-X012-D100-A32-Z12-H |

YüzeY Frezeler / Face Milling Tools

| 90° | AFM90-XN.. | Uç / Insert | Takım Kodu / Tool Code |
|--|------------|-------------------------|---|
|  | | XNEX 0403.. | AFM90-XN0403-D040-A16-Z05-H AFM90-XN0806-D050-A22-Z04-H |
| | | XNEX 0806.. (For SC) | AFM90-XN0806-D063-A22-Z05-H AFM90-XN0806-D080-A27-Z07-H AFM90-XN0806-D100-A32-Z08-H |

YüzeY ve Kopya Frezeler / Face and Copy Milling Tools

| ° | AFMR-QP.. | Uç / Insert | Takım Kodu / Tool Code |
|--|-----------|---------------------------|--|
|  | | QP.. 10T3.. (For SMTM) | AFMR-QP10T3-D040-A16-Z04-H AFMR-QP10T3-D050-A22-Z05-H AFMR-QP10T3-D063-A22-Z06-H |
| | | QP.. 1204.. (For SMTM) | AFMR-QP1204-D050-A22-Z04-H AFMR-QP1204-D063-A22-Z05-H |

S Sistem YüzeY Parmak Frezeler / S System End Mills

| 90° | AEM90-XD11T3 | Uç / Insert | Takım Kodu / Tool Code |
|---|--------------|----------------------------|---|
|  | | XD.T 11T3.. (For CRTZT) | AEM90-XD11T3-D16-W16-L150-Z02 AEM90-XD11T3-D17-C16-L150-Z02 AEM90-XD11T3-D20-W20-L150-Z03 AEM90-XD11T3-D21-C20-L080-Z03-H AEM90-XD11T3-D21-C20-L150-Z03 AEM90-XD11T3-D25-W25-L150-Z04 AEM90-XD11T3-D30-W25-L120-Z04 AEM90-XD11T3-D32-W32-L150-Z04 AEM90-XD11T3-D33-C20-L080-Z04-H |

YüzeY Frezeler / Face Milling Tools

| 42° | AFM42C-XD0806 | Uç / Insert | Takım Kodu / Tool Code |
|--|---------------|--------------------------|--|
|  | | XDMW 0806.. (For DJT) | AFM42C-XD0806-D063-A27-Z04-H AFM42C-XD0806-D080-A27-Z05-H AFM42C-XD0806-D100-A32-Z06-H AFM42C-XD0806-D125-B40-Z07 AFM42C-XD0806-D160-C40-Z08 AFM42C-XD0806-D200-C60-Z09 |

YüzeY Frezeler / Face Milling Tools

| 45° | AFM45C-XN0806 | Uç / Insert | Takım Kodu / Tool Code |
|---|---------------|--------------------------|--|
|  | | XNNU 0806.. (For DJT) | AFM45C-XN0806-D063-A22-Z05 AFM45C-XN0806-D080-A27-Z06 AFM45C-XN0806-D100-A32-Z08 AFM45C-XN0806-D125-B40-Z08 AFM45C-XN0806-D160-C40-Z10 AFM45C-XN0806-D200-C60-Z12 |

YüzeY Frezeler / Face Milling Tools

| 45° | AFM45-XN0906 | Uç / Insert | Takım Kodu / Tool Code |
|--|--------------|---------------------------|--|
|  | | XNNU 0906.. (For TGTC) | AFM45-XN0906-D063-A22-Z06-H AFM45-XN0906-D080-A27-Z06-H AFM45-XN0906-D100-A32-Z07-H AFM45-XN0906-D125-B40-Z08 |

S Sistem YüzeY Parmak Frezeler / S System End Mills

YüzeY Frezeler / Face Milling Tools

| 75° | AFM75-X012 | Uç / Insert | Takım Kodu / Tool Code |
|---|------------|-------------------------|---|
|  | | XO.. 1204.. (For SC) | AFM75-X012-D050-A22-Z04-H AFM75-X012-D063-A22-Z05-H AFM75-X012-D080-A27-Z06-H |

| 90° | AEM90-ZP13T3 | Uç / Insert | Takım Kodu / Tool Code |
|--|--------------|--------------------------|---|
|  | | ZPMT 13T3.. (For DJT) | AEM90-ZP13T3-D26-C25-L200-Z02 AEM90-ZP13T3-D26-C25-L200-Z03 AEM90-ZP13T3-D26-C25-L250-Z02 AEM90-ZP13T3-D33-C32-L200-Z03 AEM90-ZP13T3-D33-C32-L250-Z03 |

S Sistem Yüzeş Parmak Frezeler / S System End Mills

| 90° | AEM90-ZC1003 | Uç / Insert | Takım Kodu / Tool Code |
|---|--------------|---------------------------|-------------------------------|
|  | | ZCMT 100308R (For DJT) | AEM90-ZC1003-D16-C14-L150-Z02 |
| | | | AEM90-ZC1003-D16-C14-L200-Z02 |
| | | | AEM90-ZC1003-D16-C15-L150-Z02 |
| | | | AEM90-ZC1003-D16-C16-L150-Z02 |
| | | | AEM90-ZC1003-D17-C16-L150-Z02 |
| | | | AEM90-ZC1003-D17-C16-L200-Z02 |
| | | | AEM90-ZC1003-D20-C18-L150-Z03 |
| | | | AEM90-ZC1003-D20-C18-L200-Z02 |
| | | | AEM90-ZC1003-D20-C20-L150-Z03 |
| | | | AEM90-ZC1003-D20-C18-L200-Z03 |
| | | | AEM90-ZC1003-D21-C20-L150-Z02 |
| | | | AEM90-ZC1003-D21-C20-L150-Z03 |
| | | | AEM90-ZC1003-D21-C20-L200-Z03 |
| | | | AEM90-ZC1003-D25-C20-L150-Z03 |
| | | | AEM90-ZC1003-D25-C25-L150-Z03 |
| | | | AEM90-ZC1003-D26-C25-L170-Z03 |
| | | | AEM90-ZC1003-D26-C25-L200-Z03 |
| | | | AEM90-ZC1003-D32-C25-L180-Z04 |
| | | | AEM90-ZC1003-D33-C32-L200-Z04 |

S Sistem Yüzeş ve Kopya Parmak Frezeler / S System Face and Copy End Mills

| -° | AEMR-QP.. | Uç / Insert | Takım Kodu / Tool Code |
|--|-----------|--------------------------|--------------------------------|
|  | | QP. 10T3.. (For SMTM) | AEMR-QP10T3-D20-C20-L150-Z01-H |
| | | | AEMR-QP10T3-D25-C25-L120-Z02-H |
| | | | AEMR-QP10T3-D25-C25-L150-Z02-H |
| | | | AEMR-QP10T3-D25-C25-L170-Z02 |
| | | | AEMR-QP10T3-D32-C32-L150-Z03-H |
| | | | AEMR-QP10T3-D32-C32-L170-Z03 |
| | | | AEMR-QP1204-D25-C25-L150-Z02-H |
| | | | |
| | | | |
| | | | |
| | | | |

S Sistem Yüzeş ve Kopya Parmak Frezeler / S System Face and Copy End Mills

| -° | AEMRC-RD.. | Uç / Insert | Takım Kodu / Tool Code | |
|---|-------------------------------|-------------------------|---------------------------------|---------------------------------|
|  | | RD. 0501.. (For ISO) | AEMR-RD0501-D08-W10-L100-Z01-H | |
| | | | AEMR-RD0501-D10-W12-L100-Z02-H | |
| | | | AEMR-RD0501-D12-W12-L120-Z02-H | |
| | | | | |
| | | | RD. 08T2.. (For ISO) | AEMR-RD08T2-D16-W16-L150-Z02 |
| | | | | AEMR-RD08T2-D20-W20-L150-Z02 |
| | | | | |
| | | | RD. 0803.. (For ISO) | AEMR-RD0803-D16-W16-L150-Z02 |
| | | | | AEMR-RD0803-D16-C20-L200-Z02 |
| | | | | AEMR-RD0803-D20-W20-L150-Z03 |
| | | | RD. 1003.. (For ISO) | AEMRC-RD1003-D20-W20-L150-Z02 |
| | | | | AEMRC-RD1003-D20-C20-L160-Z02 |
| | | | | AEMRC-RD1003-D20-C20-L250-Z02 |
| | | | | AEMRC-RD1003-D21-C20-L160-Z02 |
| | | | | AEMRC-RD1003-D25-W25-L150-Z02 |
| | | | | AEMRC-RD1003-D25-C25-L160-Z02 |
| | | | | AEMRC-RD1003-D25-W25-L200-Z02 |
| | | | | AEMRC-RD1003-D25-C25-L200-Z02 |
| | | | | AEMRC-RD1003-D25-C25-L250-Z02 |
| | | | | AEMRC-RD1003-D26-C25-L160-Z02 |
| | | | | AEMRC-RD1003-D32-W32-L150-Z03 |
| | | | | AEMRC-RD1003-D32-C32-L250-Z02 |
| | | | | AEMRC-RD1003-D33-C32-L160-Z03 |
| | | | | AEMRC-RD1003-D40-W32-L150-Z04 |
| | | | | AEMRC-RD1003-D40-C32-L250-Z02 |
| | | | | AEMRC-RD10T3-D20-C20-L150-Z02 |
| | | | | AEMRC-RD10T3-D20-W20-L150-Z02 |
| | | | | AEMRC-RD10T3-D25-C25-L150-Z02 |
| | | | | AEMRC-RD10T3-D25-W25-L150-Z02 |
| | | | | AEMRC-RD10T3-D32-W32-L150-Z03 |
| | | | | AEMRC-RD10T3-D25-C25-L200-Z02-H |
| | | | AEMRC-RD10T3-D32-C25-L250-Z03-H | |
| | | | RD. 12T3.. (For ISO) | AEMRC-RD12T3-D25-W25-L150-Z02 |
| | | | | AEMRC-RD12T3-D25-W25-L200-Z02 |
| | | | | AEMRC-RD12T3-D25-C25-L250-Z02 |
| | | | | AEMRC-RD12T3-D25-C25-L300-Z02 |
| | | | | AEMRC-RD12T3-D32-W32-L150-Z03 |
| | | | | AEMRC-RD12T3-D32-C32-L250-Z02 |
| | | | | AEMRC-RD12T3-D40-W32-L150-Z04 |
| | | | | AEMRC-RD12T3-D40-C32-L250-Z02 |
| | | | | |
| | | | | |
| | | | RD. 1204.. (For ISO) | AEMRC-RD1204-D32-C32-L160-Z03 |
| | | | | AEMRC-RD1204-D32-W32-L160-Z03 |
| | | | | AEMRC-RD1204-D33-C32-L160-Z03 |
| RD. 1604 (For ISO) | AEMRC-RD1604-D40-W32-L150-Z02 | | | |

S Sistem Modüler Parmak Frezeler / S System Modular End Mills (Screw Type Tools)

| -° | AEMR-QP10T3 | Uç / Insert | Takım Kodu / Tool Code |
|--|-------------|--------------------------|-------------------------------|
|  | | QP. 10T3.. (For SMTM) | AEMR-QP10T3-D25-M12-L35-Z02-H |
| | | | AEMR-QP10T3-D32-M16-L43-Z03-H |



| -° | AEMR-RC10T3 | Uç / Insert | Takım Kodu / Tool Code |
|--|-------------|-------------------------|-------------------------------|
|  | | RC. 10T3.. (For ZCC) | AEMR-RC10T3-D25-M12-L35-Z03-H |
| | | | AEMR-RC10T3-D32-M16-L43-Z04-H |
| | | | AEMR-RC10T3-D40-M16-L43-Z05-H |
| | | | |

Yüzeş ve Kopya Frezeler / Face and Copy Milling Tools

| -° | AFMR-RC10T3 | Uç / Insert | Takım Kodu / Tool Code |
|--|-------------|-------------------------|----------------------------|
|  | | RC. 10T3.. (For ZCC) | AFMR-RC10T3-D040-A16-Z04-H |
| | | | AFMR-RC10T3-D050-A22-Z05-H |
| | | | AFMR-RC10T3-D063-A22-Z06-H |

| -° | AFMR-RC1204 | Uç / Insert | Takım Kodu / Tool Code |
|---|-------------|---------------------------|----------------------------|
|  | | RC. 1204.. (For SNDVK) | AFMR-RC1204-D040-A16-Z04-H |
| | | | AFMR-RC1204-D050-A22-Z05-H |
| | | | AFMR-RC1204-D052-A22-Z05-H |
| | | | AFMR-RC1204-D063-A22-Z06-H |
| | | | AFMR-RC1204-D063-A27-Z06-H |
| | | | AFMR-RC1204-D080-A27-Z07-H |

S Sistem Modüler Parmak Frezeler / S System Modular End Mills (Screw Type Tools)

| -° | AEMR-RD.. | Uç / Insert | Takım Kodu / Tool Code |
|--|-------------------------------|-----------------------|-------------------------------|
|   | | RD. 0702 (For ISO) | AEMR-RD0702-D15-M08-L23-Z02-H |
| | | | AEMR-RD0702-D16-M08-L23-Z02-H |
| | | | AEMR-RD0702-D20-M10-L30-Z04-H |
| | | | AEMR-RD0702-D25-M12-L35-Z05-H |
| | | | AEMR-RD0702-D30-M16-L42-Z05-H |
| | | | AEMR-RD0702-D32-M16-L43-Z05-H |
| | | | AEMR-RD0702-D35-M16-L42-Z06-H |
| | | | AEMR-RD0702-D42-M16-L43-Z05-H |
| | | | AEMR-RD0702-D42-M16-L43-Z07-H |
| | | | AEMR-RD08T2-D16-M08-L23-Z02-H |
| | | | AEMR-RD08T2-D16-M10-L23-Z02-H |
| | | | AEMR-RD08T2-D20-M10-L30-Z03-H |
| | | | AEMR-RD08T2-D25-M12-L35-Z04-H |
| | | | AEMR-RD10T3-D25-M12-L35-Z03-H |
| | | | AEMR-RD10T3-D32-M16-L45-Z04-H |
| | | | AEMR-RD0803-D16-M08-L23-Z02-H |
| | | | AEMR-RD0803-D20-M10-L30-Z03-H |
| | | | AEMR-RD0803-D25-M12-L35-Z04-H |
| | | | AEMR-RD1003-D20-M10-L30-Z02-H |
| | | | AEMR-RD1003-D25-M12-L35-Z02-H |
| | | | AEMR-RD1003-D25-M12-L35-Z03-H |
| | | | AEMR-RD1003-D30-M16-L43-Z04-H |
| | | | AEMR-RD1003-D32-M16-L43-Z04-H |
| | | | AEMR-RD1003-D35-M16-L43-Z04-H |
| AEMR-RD1003-D40-M16-L43-Z05-H | | | |
| AEMR-RD1003-D42-M16-L43-Z05-H | | | |
| RD. 1004 (For ISO) | AEMR-RD1004-D25-M12-L35-Z03-H | | |
| AEMR-RD1004-D32-M16-L43-Z04-H | | | |
| AEMR-RD12T3-D24-M12-L35-Z02-H | | | |
| AEMR-RD12T3-D25-M12-L35-Z02-H | | | |
| RD. 12T3 (For ISO) | AEMR-RD12T3-D32-M16-L43-Z03-H | | |
| AEMR-RD12T3-D35-M16-L43-Z03-H | | | |
| AEMR-RD12T3-D35-M16-L43-Z04-H | | | |
| AEMR-RD12T3-D40-M16-L43-Z04-H | | | |
| AEMR-RD12T3-D42-M16-L43-Z05-H | | | |
| RD. 1204 (For ISO) | AEMR-RD1204-D32-M16-L43-Z03-H | | |
| AEMR-RD1204-D42-M16-L43-Z04-H | | | |
| RD. 1604 (For ISO) | AEMR-RD1604-D32-M16-L43-Z02-H | | |
| AEMR-RD1604-D40-M16-L43-Z02-H | | | |
| AEMR-RD1604-D42-M16-L43-Z03-H | | | |

Frezeleme Takımları / Milling Tools

Yüzey ve Kopya Frezeler / Face and Copy Milling Tools

| -° | AFMRC-RD.. | Uç / Insert | Takım Kodu / Tool Code |
|----|------------|----------------------|---|
| | | RD..0702.. (For ISO) | AFMR-RD0702-D050-A22-Z06-H |
| | | RD..0803.. (For ISO) | AFMR-RD0803-D050-A22-Z05-H |
| | | RD..1003.. (For ISO) | AFMRC-RD1003-D040-A16-Z04-H AFMRC-RD1003-D050-A22-Z05-H AFMRC-RD1003-D052-A22-Z05 AFMRC-RD1003-D063-A22-Z06-H AFMRC-RD1003-D080-A27-Z07-H AFMRC-RD1003-D100-A32-Z08-H |
| | | RD..10T3.. (For ISO) | AFMRC-RD10T3-D050-A22-Z05-H AFMRC-RD10T3-D063-A22-Z06-H |
| | | RD..12T3.. (For ISO) | AFMRC-RD12T3-D040-A16-Z04-H AFMRC-RD12T3-D050-A22-Z05-H AFMRC-RD12T3-D052-A22-Z05-H AFMRC-RD12T3-D063-A22-Z06-H AFMRC-RD12T3-D080-A27-Z07-H AFMRC-RD12T3-D100-A32-Z08-H AFMRC-RD12T3-D125-B40-Z09 |
| | | RD..1204.. (For ISO) | AFMRC-RD1204-D040-A16-Z04-H AFMRC-RD1204-D050-A22-Z05-H AFMRC-RD1204-D052-A22-Z05-H AFMRC-RD1204-D063-A22-Z06-H AFMRC-RD1204-D080-A27-Z07-H AFMRC-RD1204-D100-A32-Z07-H AFMRC-RD1204-D100-A32-Z08-H |
| | | RD..1604.. (For ISO) | AFMRC-RD1604-D050-A22-Z04-H AFMRC-RD1604-D052-A22-Z04-H AFMRC-RD1604-D063-A22-Z05-H AFMRC-RD1604-D066-A22-Z05-H AFMRC-RD1604-D066-A27-Z05-H AFMRC-RD1604-D080-A27-Z06-H AFMRC-RD1604-D100-A32-Z07-H AFMRC-RD1604-D125-B40-Z07 AFMRC-RD1604-D160-C40-Z08 |



S Sistem Yüzey ve Kopya Parmak Frezeler / S System Face and Copy End Mills

| -° | AEMR-RP10T3 | Uç / Insert | Takım Kodu / Tool Code |
|----|-------------|-------------------------|--|
| | | RPNX 10T3.. (For CRTZT) | AEMR-RP10T3-D25-W25-L125-Z02 AEMR-RP10T3-D25-W25-L150-Z02 AEMR-RP10T3-D32-W32-L150-Z03 |



S Sistem Modüler Parmak Frezeler / S System Modular End Mills (Screw Type Tools)

| -° | AEMR-RP10T3 | Uç / Insert | Takım Kodu / Tool Code |
|----|-------------|-------------------------|--|
| | | RPNX 10T3.. (For CRTZT) | AEMR-RP10T3-D25-M12-L35-Z02-H AEMR-RP10T3-D32-M16-L43-Z03-H |
| | | RPNX 1204.. (For CRTZT) | AEMR-RP1204-D32-M16-L43-Z03-H |



Yüzey ve Kopya Frezeler / Face and Copy Milling Tools

| -° | AFMR-RP.. | Uç / Insert | Takım Kodu / Tool Code |
|----|-----------|-------------------------|--|
| | | RPNX 10T3.. (For CRTZT) | AFMR-RP10T3-D063-A22-Z06-H AFMR-RP10T3-D080-A27-Z07-H |
| | | RPNX 1204.. (For CRTZT) | AFMR-RP1204-D040-A16-Z04-H AFMR-RP1204-D080-A27-Z07-H |



S Sistem Modüler Parmak Frezeler / S System Modular End Mills (Screw Type Tools)

| -° | AEMR-RY.. | Uç / Insert | Takım Kodu / Tool Code |
|----|-----------|------------------------|--|
| | | RYMX 1004.. (For TGTC) | AEMR-RY10-D32-M16-L43-Z04-H AEMR-RY10-D40-M16-L43-Z05-H |
| | | RYMX 1205.. (For TGTC) | AEMR-RY12-D32-M16-L43-Z03-H AEMR-RY12-D40-M16-L43-Z03-H |



S Sistem Modüler Parmak Frezeler / S System Modular End Mills (Screw Type Tools)

| -° | AEMR-RP.. | Uç / Insert | Takım Kodu / Tool Code |
|----|-----------|--------------------------|--|
| | | RPMT 08T2.. (For MTSBSH) | AEMR-RP08T2M-D20-M10-L30-Z02-H |
| | | RPMT 10T3.. (For MTSBSH) | AEMR-RP10T3M-D25-M12-L35-Z02-H AEMR-RP10T3M-D32-M16-L43-Z03-H |
| | | RPMT 1204 (For MTSBSH) | AEMR-RP1204M-D32-M16-L43-Z03-H AEMR-RP1204M-D40-M16-L43-Z04-H |



S Sistem Yüzey ve Kopya Parmak Frezeler / S System Face and Copy End Mills

| -° | AEMR-RP.. | Uç / Insert | Takım Kodu / Tool Code |
|----|-----------|--------------------------|--|
| | | RPMT 08T2.. (For MTSBSH) | AEMR-RP08T2M-D20-W20-L150-Z02-H AEMR-RP08T2M-D25-W25-L200-Z03-H |
| | | RPMT 10T3.. (For MTSBSH) | AEMR-RP10T3M-D25-W25-L200-Z02-H AEMR-RP10T3M-D32-W32-L200-Z03-H |
| | | RPMT 1204.. (For MTSBSH) | AEMR-RP1204M-D32-W32-L150-Z03-H AEMR-RP1204M-D32-W32-L200-Z03-H |
| | | RPMT 1606.. (For MTSBSH) | AEMR-RP1606M-D40-W32-L150-Z02-H AEMR-RP1606M-D40-W32-L200-Z02-H |



Yüzey ve Kopya Frezeler / Face and Copy Milling Tools

| -° | AEMR-RY.. | Uç / Insert | Takım Kodu / Tool Code |
|----|-----------|------------------------|--|
| | | RYMX 0803.. | AEMR-RY08-D16-W16-L150-Z02 AEMR-RY10-D20-W20-L150-Z02 AEMR-RY10-D20-C20-L200-Z02 |
| | | RYMX 1004.. (For TGTC) | AEMR-RY10-D21-W20-L200-Z02-H AEMR-RY10-D25-W25-L150-Z02 AEMR-RY10-D25-W25-L150-Z03 AEMR-RY10-D26-W25-L200-Z02-H AEMR-RY10-D32-W32-L160-Z04-H |
| | | RYMX 1205.. | AEMR-RY12-D32-C25-L160-Z03 |



Yüzey ve Kopya Frezeler / Face and Copy Milling Tools

Yüzey ve Kopya Frezeler / Face and Copy Milling Tools

| -° | AFMR-RP1204M | Uç / Insert | Takım Kodu / Tool Code |
|----|--------------|--------------------------|--|
| | | RPMT 1204.. (For MTSBSH) | AFMR-RP1204M-D050-A22-Z04-H AFMR-RP1204M-D052-A22-Z05-H AFMR-RP1204M-D063-A22-Z05-H AFMR-RP1204M-D080-A27-Z06-H |



| -° | AFMR-RY.. | Uç / Insert | Takım Kodu / Tool Code |
|----|-----------|------------------------|--|
| | | RYMX 1004.. (For TGTC) | AFMR-RY10-D040-A16-Z04-H AFMR-RY10-D050-A22-Z05-H AFMR-RY10-D063-A22-Z06-H AFMR-RY12-D040-A16-Z04-H AFMR-RY12-D050-A22-Z05-H |
| | | RYMX 1205.. (For TGTC) | AFMR-RY12-D052-A22-Z05-H AFMR-RY12-D063-A22-Z06-H AFMR-RY12-D080-A27-Z06-H AFMR-RY12-D100-A32-Z07-H |



Küre Uçlu Parmak Frezeler / Profile Milling Tools

| -° | APMR-BNM.. | Uç / Insert | Takım Kodu / Tool Code |
|---|---------------------|-------------|---|
|  | BNM-120-S (For DJT) | | APMR-BNM12-D12-C12-L130 |
| | BNM-160-S (For DJT) | | APMR-BNM16-D16-C16-L175 APMR-BNM16-D16-C16-L200 |
| | BNM-200-S (For DJT) | | APMR-BNM20-D20-C20-L160 APMR-BNM20-D20-C20-L200 |
| | BNM-250-S (For DJT) | | APMR-BNM25-D25-C25-L160 APMR-BNM25-D25-C25-L200 APMR-BNM25-D25-C25-L250 |

Küre Uçlu Parmak Frezeler / Profile Milling Tools

| -° | APMR-P32.. | Uç / Insert | Takım Kodu / Tool Code |
|---|--------------------|-------------|--|
|  | P3208 - (For WLTR) | | APMR-P3208-D08-C10-L110 |
| | P3210 - (For WLTR) | | APMR-P3210-D10-C10-L130 APMR-P3210-D10-C12-L130 |
| | P3212 - (For WLTR) | | APMR-P3212-D12-C12-L130 |
| | P3216 - (For WLTR) | | APMR-P3216-D16-C16-L175 |
| | P3220 - (For WLTR) | | APMR-P3220-D20-C20-L200 |
| | P3225 - (For WLTR) | | APMR-P3225-D25-C25-L200 |
| | P3232 - (For WLTR) | | APMR-P3232-D32-C32-L200 |

Küre Uçlu Modüler Parmak Frezeler / Ball Nose Modular End Mills (Screw Type Tools)

| -° | APMR-PR.. | Uç / Insert | Takım Kodu / Tool Code |
|---|--------------------|-------------|------------------------|
|  | P3216 - (For WLTR) | | APMR-P3216-D16-M08-L25 |
| | P3220 - (For WLTR) | | APMR-P3220-D20-M10-L30 |
| | P3225 - (For WLTR) | | APMR-P3225-D25-M12-L35 |
| | P3232 - (For WLTR) | | APMR-P3232-D32-M16-L43 |

Küre Uçlu Parmak Frezeler / Profile Milling Tools

| -° | APMR-RO.. | Uç / Insert | Takım Kodu / Tool Code |
|---|---------------------|-------------|--|
|  | ROHX 1203 (For ZCC) | | APMR-RO12-D12-C12-L120 APMR-RO12-D12-C16-L160 |
| | ROHX 1604 (For ZCC) | | APMR-RO16-D16-C16-L160 APMR-RO16-D16-C16-L200 APMR-RO16-D16-C20-L200 |
| | ROHX 2005 (For ZCC) | | APMR-RO20-D20-C20-L160 APMR-RO20-D20-C20-L200 APMR-RO20-D20-C25-L220 |

Küre Uçlu Modüler Parmak Frezeler / Ball Nose Modular End Mills (Screw Type Tools)

| -° | APMR-XP.. | Uç / Insert | Takım Kodu / Tool Code |
|---|--------------------------|-------------|------------------------|
|  | XPHT 16R0803 - (For ZCC) | | APMR-XP16-D16-M08-L25 |
| | XPHT 20R10T3 - (For ZCC) | | APMR-XP20-D20-M10-L30 |
| | XPHT 25R1204 - (For ZCC) | | APMR-XP25-D25-M12-L40 |

Küre Uçlu Parmak Frezeler / Profile Milling Tools

| -° | APMR-XP.. | Uç / Insert | Takım Kodu / Tool Code |
|---|--------------------------|-------------|------------------------|
|  | XPHT 16R0803 - (For ZCC) | | APMR-XP16-D16-C16-L150 |
| | XPHT 20R10T3 - (For ZCC) | | APMR-XP20-D20-C20-L150 |
| | XPHT 25R1204 - (For ZCC) | | APMR-XP25-D25-C25-L150 |

Küre Uçlu Modüler Parmak Frezeler / Ball Nose Modular End Mills (Screw Type Tools)

| -° | APMR-SWB.. | Uç / Insert | Takım Kodu / Tool Code |
|--|-------------------------|-------------|-------------------------|
|  | SWB225HM-HS - (For DJT) | | APMR-SWB225-D25-M12-L35 |
| | SWB230HM-HS - (For DJT) | | APMR-SWB230-D30-M16-L43 |
| | SWB232HM-HS - (For DJT) | | APMR-SWB232-D32-M16-L43 |

S Sistem Hızlı İlerlemeli Parmak Frezeler / S System Highfeed End Mills

| -° | AHFM-BL.. | Uç / Insert | Takım Kodu / Tool Code |
|--|------------------------|-------------|--|
|  | BLMP 0603.. (For TGTC) | | AHFM-BL0603-D16-C15-L150-Z02 AHFM-BL0603-D16-C16-L100-Z02-H AHFM-BL0603-D16-C16-L150-Z02 AHFM-BL0603-D17-C16-L150-Z02 AHFM-BL0603-D17-W16-L170-Z02 AHFM-BL0603-D17-W16-L170-Z02-H AHFM-BL0603-D17-C16-L200-Z02 AHFM-BL0603-D18-C16-L150-Z02 AHFM-BL0603-D18-W16-L150-Z02-H AHFM-BL0603-D20-C20-L130-Z03 AHFM-BL0603-D20-C20-L160-Z03 AHFM-BL0603-D21-W20-L200-Z03 AHFM-BL0603-D21-C20-L200-Z03 AHFM-BL0603-D22-W20-L150-Z03 AHFM-BL0603-D25-C25-L250-Z04 AHFM-BL0603-D26-W25-L200-Z04 AHFM-BL0603-D26-C25-L200-Z04 AHFM-BL0603-D26-C25-L250-Z04 AHFM-BL0603-D32-C32-L150-Z05 AHFM-BL0603-D32-C32-L200-Z05 AHFM-BL0603-D33-C32-L150-Z05 AHFM-BL0603-D33-C32-L200-Z05 AHFM-BL0603-D33-C32-L250-Z05 |
| | | BLMP 0904.. | AHFM-BL0904-D28-W25-L180-Z03 |

S Sistem Hızlı İlerlemeli Modüler Parmak Frezeler / S System Modular Highfeed End Mills (Screw Type Tools)

| -° | AHFM-BL.. | Uç / Insert | Takım Kodu / Tool Code |
|--|----------------------|-------------|---|
|  | BLMP 0603 (For TGTC) | | AHFM-BL0603-D20-M10-L30-Z03-H AHFM-BL0603-D32-M16-L40-Z05-H |
| | BLMP 0904 (For TGTC) | | AHFM-BL0904-D32-M16-L40-Z04-H AHFM-BL0904-D32-M16-L43-Z04-H AHFM-BL0904-D42-M16-L43-Z05-H |

Hızlı İlerlemeli Frezeler / High Feed Milling Tools

| -° | AHFM-BL.. | Uç / Insert | Takım Kodu / Tool Code |
|--|------------------------|-------------|--|
|  | BLMP 0603.. (For TGTC) | | AHFM-BL0603-D040-A16-Z06-H AHFM-BL0603-D050-A22-Z07-H AHFM-BL0904-D040-A16-Z05-H |
| | BLMP 0904.. (For TGTC) | | AHFM-BL0904-D050-A22-Z06-H AHFM-BL0904-D063-A22-Z05-H AHFM-BL0904-D063-A22-Z07-H |

Hızlı İlerlemeli Frezeler / High Feed Milling Tools

| -° | AHFM-BL1205 | Uç / Insert | Takım Kodu / Tool Code |
|--|------------------------|-------------|--|
|  | BLMP 1205.. (For TGTC) | | AHFM-BL1205-D050-A22-Z03-H AHFM-BL1205-D063-A22-Z04-H AHFM-BL1205-D080-A27-Z05-H |

Frezeleme Takımları / Milling Tools

S Sistem Hızlı İlerlemeli Parmak Frezeler / S System Highfeed End Mills

| ° | AHFM-BN10T3 | Uç / Insert | Takım Kodu / Tool Code |
|---|---|---------------------------|--|
| |  | BNGX 10T3.. (For PRMT) | AHFM-BN10T3-D16-C16-L100-Z02-H AHFM-BN10T3-D16-C16-L150-Z02-H AHFM-BN10T3-D20-C20-L130-Z03-H AHFM-BN10T3-D20-C20-L130-Z04-H AHFM-BN10T3-D20-C20-L160-Z03-H AHFM-BN10T3-D25-C25-L140-Z04-H AHFM-BN10T3-D25-W25-L140-Z04-H AHFM-BN10T3-D25-C25-L140-Z05-H AHFM-BN10T3-D25-C25-L180-Z04-H AHFM-BN10T3-D32-C32-L150-Z05-H AHFM-BN10T3-D32-C32-L150-Z06-H AHFM-BN10T3-D35-C32-L200-Z06-H |

S Sistem Hızlı İlerlemeli Parmak Frezeler / S System Highfeed End Mills

| ° | AHFM-E00602 | Uç / Insert | Takım Kodu / Tool Code |
|---|--|---|--|
| |  | EO.. 060210 ZOMT 060210 (For DJT) | AHFM-E00602-D10-C10-L080-Z02 AHFM-E00602-D10-C09-L120-Z02 AHFM-E00602-D10-C10-L120-Z02 AHFM-E00602-D12-C12-L080-Z02 AHFM-E00602-D12-C12-L080-Z03 AHFM-E00602-D12-C11-L120-Z02 AHFM-E00602-D12-C11-L120-Z03 AHFM-E00602-D12-C12-L120-Z02 AHFM-E00602-D12-C12-L120-Z03 AHFM-E00602-D16-C16-L150-Z04 |

S Sistem Hızlı İlerlemeli Modüler Parmak Frezeler / S System Modular Highfeed End Mills (Screw Type Tools)

| ° | AHFM-ED0702 | Uç / Insert | Takım Kodu / Tool Code |
|---|---|--|---|
| |  | EDMT 0702 - JDMT 070204 (For HTCH) | AHFM-ED0702-D12-M06-L20-Z03 AHFM-ED0702-D16-M08-L25-Z04-H AHFM-ED0702-D20-M10-L30-Z05-H AHFM-ED0702-D25-M12-L30-Z06-H AHFM-ED0702-D32-M16-L30-Z08-H |

S Sistem Hızlı İlerlemeli Parmak Frezeler / S System Highfeed End Mills

| ° | AHFM-EP1003 | Uç / Insert | Takım Kodu / Tool Code |
|---|--|--|--|
| |  | EP.. 1003.. ZPMT 1003.. YPHW 1003.. (For DJT) | AHFM-EP1003-D16-C16-L150-Z02-H AHFM-EP1003-D17-C16-L150-Z02-H AHFM-EP1003-D20-C20-L150-Z04-H AHFM-EP1003-D21-C20-L150-Z04-H AHFM-EP1003-D25-C25-L200-Z04-H AHFM-EP1003-D25-C25-L250-Z04-H |

S Sistem Hızlı İlerlemeli Modüler Parmak Frezeler / S System Modular Highfeed End Mills (Screw Type Tools)

| ° | AHFM-EN1004 | Uç / Insert | Takım Kodu / Tool Code |
|---|---|--------------------------|--|
| |  | ENMU 1004.. (For DJT) | AHFM-EN1004-D16-M08-L23-Z02-H AHFM-EN1004-D20-M10-L30-Z03-H AHFM-EN1004-D25-M12-L35-Z03-H AHFM-EN1004-D25-M12-L35-Z04-H AHFM-EN1004-D32-M16-L43-Z05-H AHFM-EN1004-D35-M16-L43-Z05-H AHFM-EN1004-D40-M16-L43-Z05-H AHFM-EN1004-D42-M16-L43-Z05-H |

S Sistem Hızlı İlerlemeli Modüler Parmak Frezeler / S System Modular Highfeed End Mills (Screw Type Tools)

| ° | AHFM-EP1003 | Uç / Insert | Takım Kodu / Tool Code |
|---|--|--|--|
| |  | EP.. 1003.. ZPMT 1003.. YPHW 1003.. (For DJT) | AHFM-EP1003-D16-M08-L23-Z02-H AHFM-EP1003-D20-M10-L30-Z04-H AHFM-EP1003-D25-M12-L35-Z04-H AHFM-EP1003-D32-M16-L43-Z05-H AHFM-EP1003-D35-M16-L43-Z05-H AHFM-EP1003-D42-M16-L43-Z06-H |

Hızlı İlerlemeli Frezeler / High Feed Milling Tools

| ° | AHFM-EN1004 | Uç / Insert | Takım Kodu / Tool Code |
|---|---|--------------------------|--|
| |  | ENMU 1004.. (For DJT) | AHFM-EN1004-D050-A22-Z05-H AHFM-EN1004-D050-A22-Z06-H AHFM-EN1004-D052-A22-Z06-H AHFM-EN1004-D063-A22-Z06-H |

Hızlı İlerlemeli Frezeler / High Feed Milling Tools

| ° | AHFM-EP1003 | Uç / Insert | Takım Kodu / Tool Code |
|---|--|--|--|
| |  | EP.. 1003.. ZPMT 1003.. YPHW 1003.. (For DJT) | AHFM-EP1003-D050-A22-Z08-H AHFM-EP1003-D063-A22-Z08-H |

S Sistem Hızlı İlerlemeli Parmak Frezeler / S System Highfeed End Mills

| ° | AHFM-EN1004 | Uç / Insert | Takım Kodu / Tool Code |
|---|---|--------------------------|--|
| |  | ENMU 1004.. (For DJT) | AHFM-EN1004-D16-C15-L150-Z02 AHFM-EN1004-D16-C16-L150-Z02 AHFM-EN1004-D16-C16-L250-Z02 AHFM-EN1004-D17-C16-L150-Z02-H AHFM-EN1004-D17-C16-L150-Z02 AHFM-EN1004-D17-C16-L200-Z02 AHFM-EN1004-D18-C16-L150-Z02 AHFM-EN1004-D20-C20-L150-Z03 AHFM-EN1004-D20-C20-L250-Z03 AHFM-EN1004-D21-C20-L150-Z02 AHFM-EN1004-D21-C20-L150-Z03 AHFM-EN1004-D21-C20-L150-Z03-H AHFM-EN1004-D21-C20-L200-Z03 AHFM-EN1004-D22-C20-L150-Z03 AHFM-EN1004-D25-C25-L150-Z03 AHFM-EN1004-D25-C25-L150-Z04 AHFM-EN1004-D26-C25-L150-Z03 AHFM-EN1004-D26-C25-L150-Z04 AHFM-EN1004-D26-C25-L200-Z03 AHFM-EN1004-D26-C25-L200-Z03-H AHFM-EN1004-D26-C25-L250-Z03-H AHFM-EN1004-D28-C25-L200-Z04 AHFM-EN1004-D32-C32-L200-Z04 AHFM-EN1004-D33-C32-L200-Z04 AHFM-EN1004-D33-C32-L200-Z04-H |

Hızlı İlerlemeli Frezeler / High Feed Milling Tools

| ° | AHFMC-JD.. | Uç / Insert | Takım Kodu / Tool Code |
|---|--|-----------------------------|---|
| |  | JDMW 1204.. (For MTSBSH) | AHFMC-JD1204-D052-A22-Z03-H AHFMC-JD1204-D052-A22-Z04-H AHFMC-JD1204-D063-A22-Z05-H AHFMC-JD1204-D080-A27-Z06-H AHFMC-JD1204-D100-A32-Z07-H |
| | | JDMW 1405.. (For MTSBSH) | AHFMC-JD1405-D052-A22-Z03-H AHFMC-JD1405-D063-A22-Z04-H |

S Sistem Hızlı İlerlemeli Parmak Frezeler / S System Highfeed End Mills

| ° | AHFMC-JD1204 | Uç / Insert | Takım Kodu / Tool Code |
|---|--|-----------------------------|--|
| |  | JDMW 1204.. (For MTSBSH) | AHFMC-JD1204-D32-C32-L150-Z02 AHFMC-JD1204-D32-C32-L200-Z02 AHFMC-JD1204-D35-C32-L200-Z02 AHFMC-JD1204-D35-C32-L250-Z02 |

S Sistem Hızlı İlerlemeli Modüler Parmak Frezeler / S System Modular Highfeed End Mills (Screw Type Tools)

| ° | AHFC-JD1204 | Uç / Insert | Takım Kodu / Tool Code |
|---|---|-----------------------------|--|
| |  | JDMW 1204.. (For MTSBSH) | AHFC-JD1204-D32-M16-L43-Z02-H AHFC-JD1204-D42-M16-L43-Z03-H |

S Sistem Hızlı İlerlemeli Modüler Parmak Frezeler / S System Modular Highfeed End Mills (Screw Type Tools)

| ° | AHFM-JD1003 | Uç / Insert | Takım Kodu / Tool Code |
|---|---|---------------------------|--|
| |  | JDMT 1003.. (For HTCH) | AHFM-JD1003-D16-M08-L30-Z02-H AHFM-JD1003-D20-M10-L30-Z03-H |

Hızlı İlerlemeli Frezeler / High Feed Milling Tools

| ° | AHFM-JD1003 | Uç / Insert | Takım Kodu / Tool Code |
|---|---|---------------------------|--|
| |  | JDMT 1003.. (For HTCH) | AHFM-JD1003-D040-A16-Z06-H AHFM-JD1003-D063-A22-Z08-H |

S Sistem Hızlı İlerlemeli Parmak Frezeler / S System Highfeed End Mills

| ° | AHFM-LN0303 | Uç / Insert | Takım Kodu / Tool Code |
|---|---|----------------------------|--|
| |  | LNMU 0303.. (For TNGLY) | AHFM-LN0303-D16-C15-L150-Z02 AHFM-LN0303-D16-W16-L150-Z02-H AHFM-LN0303-D20-W20-L150-Z03-H AHFM-LN0303-D21-C20-L150-Z03 AHFM-LN0303-D25-W25-L150-Z04-H AHFM-LN0303-D26-C25-L150-Z04 AHFM-LN0303-D33-C32-L200-Z05 |

S Sistem Hızlı İlerlemeli Modüler Parmak Frezeler / S System Modular Highfeed End Mills (Screw Type Tools) Tools

| ° | AHFM-LN0303 | Uç / Insert | Takım Kodu / Tool Code |
|---|---|----------------------------|---|
| |  | LNMU 0303.. (For TNGLY) | AHFM-LN0303-D25-M12-L35-Z04-H AHFM-LN0303-D32-M16-L43-Z05-H AHFM-LN0303-D42-M16-L43-Z06-H |

S Sistem Hızlı İlerlemeli Modüler Parmak Frezeler / S System Modular Highfeed End Mills (Screw Type Tools) Tools

| ° | AHFM-L003 | Uç / Insert | Takım Kodu / Tool Code |
|---|---|---------------------------|--|
| |  | LOGU 0303.. (For KYCR) | AHFM-L003-D20-M10-L30-Z04-H-F AHFM-L003-D25-M12-L35-Z04-H-F AHFM-L003-D25-M12-L35-Z04-H AHFM-L003-D32-M16-L40-Z05-H-F AHFM-L003-D32-M16-L40-Z05-H AHFM-L003-D32-M16-L40-Z06-H-F AHFM-L003-D32-M16-L40-Z06-H AHFM-L003-D35-M16-L40-Z06-H AHFM-L003-D42-M16-L40-Z05-H AHFM-L003-D42-M16-L40-Z06-H |

S Sistem Hızlı İlerlemeli Modüler Parmak Frezeler / S System Modular Highfeed End Mills (Screw Type Tools)

| ° | AHFM-SD.. | Uç / Insert | Takım Kodu / Tool Code |
|---|---|--------------------------|---|
| |  | SD.. 06T2.. (For ZCC) | AHFM-SD06T2-D16-M08-L23-Z02-H AHFM-SD06T2-D20-M10-L30-Z03-H AHFM-SD06T2-D25-M12-L35-Z04-H AHFC-SD09T3-D25-M12-L30-Z02-H AHFC-SD09T3-D32-M16-L43-Z03-H AHFC-SD09T3-D35-M16-L43-Z03-H AHFC-SD09T3-D40-M16-L43-Z04-H |
| | | SD.. 09T3.. (For ZCC) | AHFC-SD09T3-D32-M16-L43-Z03-H AHFC-SD09T3-D35-M16-L43-Z03-H AHFC-SD09T3-D40-M16-L43-Z04-H |
| | | SD.. 1204.. (For ZCC) | AHFC-SD1204-D32-M16-L43-Z02-H AHFC-SD1204-D40-M16-L43-Z03-H |

S Sistem Hızlı İlerlemeli Parmak Frezeler / S System Highfeed End Mills

| ° | AHFM-L003 | Uç / Insert | Takım Kodu / Tool Code |
|---|--|---------------------------|--|
| |  | LOGU 0303.. (For KYCR) | AHFM-L003-D16-C15-L160-Z02 AHFM-L003-D16-C16-L100-Z02-F AHFM-L003-D16-C16-L100-Z02 AHFM-L003-D16-C16-L130-Z02-H AHFM-L003-D16-C16-L160-Z02 AHFM-L003-D16-C16-L160-Z02-H AHFM-L003-D17-C16-L180-Z02 AHFM-L003-D20-C20-L130-Z03 AHFM-L003-D20-C20-L130-Z03-H AHFM-L003-D20-C20-L160-Z03 AHFM-L003-D20-C20-L160-Z03-H AHFM-L003-D21-C20-L150-Z03-H AHFM-L003-D21-C20-L200-Z03 AHFM-L003-D21-C20-L200-Z03-H AHFM-L003-D25-C25-L140-Z04-F AHFM-L003-D25-C25-L140-Z04 AHFM-L003-D25-C25-L180-Z04 AHFM-L003-D26-C25-L250-Z04 AHFM-L003-D32-C32-L200-Z05 AHFM-L003-D33-C32-L250-Z05 |

Hızlı İlerlemeli Frezeler / High Feed Milling Tools

| ° | AHFM-L003 | Uç / Insert | Takım Kodu / Tool Code |
|---|---|---------------------------|--|
| |  | LOGU 0303.. (For KYCR) | AHFM-L003-D040-A16-Z06-H AHFM-L003-D050-A22-Z07-H AHFM-L003-D063-A22-Z09-H |

S Sistem Hızlı İlerlemeli Parmak Frezeler / S System Highfeed End Mills

| ° | AHFM-LP0102 | Uç / Insert | Takım Kodu / Tool Code |
|---|--|---------------------------|--|
| |  | LPGT 0102.. (For KYCR) | AHFM-LP0102-D10-C09-L120-Z02 AHFM-LP0102-D10-C10-L120-Z02 AHFM-LP0102-D12-C11-L120-Z02 AHFM-LP0102-D12-C12-L120-Z02 |

S Sistem Hızlı İlerlemeli Parmak Frezeler / S System Highfeed End Mills

| ° | AHFM-SD.. | Uç / Insert | Takım Kodu / Tool Code |
|---|--|--------------------------|--|
| |  | SD.. 06T2.. (For ZCC) | AHFM-SD06T2-D16-C16-L100-Z02-H AHFM-SD06T2-D16-C16-L150-Z02-H AHFM-SD06T2-D16-C16-L200-Z02 AHFM-SD06T2-D17-C16-L150-Z02-H AHFM-SD06T2-D20-C20-L150-Z03-H AHFM-SD06T2-D20-C20-L200-Z03 AHFM-SD06T2-D21-C20-L150-Z03-H AHFM-SD06T2-D25-C25-L150-Z04-H AHFM-SD06T2-D26-C25-L150-Z04-H |
| | | SD.. 09T3.. (For ZCC) | AHFC-SD09T3-D22-W20-L150-Z02 AHFC-SD09T3-D25-C25-L150-Z02 AHFC-SD09T3-D25-W25-L150-Z02 AHFM-SD09T3-D25-C25-L150-Z03 AHFC-SD09T3-D28-C25-L150-Z02 AHFC-SD09T3-D32-C32-L150-Z03 AHFC-SD09T3-D32-C32-L150-Z04 |

Hızlı İlerlemeli Frezeler / High Feed Milling Tools

| ° | AHFC-SD1204 | Uç / Insert | Takım Kodu / Tool Code |
|---|--|--------------------------|--|
| |  | SD.. 1204.. (For ZCC) | AHFC-SD1204-D050-A22-Z04-H AHFC-SD1204-D063-A22-Z05-H AHFC-SD1204-D080-A27-Z06-H AHFC-SD1204-D100-A32-Z08-H |

Frezeleme Takımları / Milling Tools

Hızlı İlerleme Frezeler / High Feed Milling Tools

| ° | AHFM-SD1205 | Uç / Insert | Takım Kodu / Tool Code |
|---|---|---------------------------|--|
| |  | SD.. 1205.. (For HTCH) | AHFM-SD1205-D052-A22-Z04-H AHFM-SD1205-D052-A22-Z05-H AHFM-SD1205-D066-A22-Z05-H AHFM-SD1205-D066-A22-Z06-H AHFM-SD1205-D080-A27-Z06-H |

S Sistem Hızlı İlerlemeli Modüler Parmak Frezeler / S System Modular Highfeed End Mills (Screw Type Tools)

| ° | AHFM-S00803 | Uç / Insert | Takım Kodu / Tool Code |
|---|---|---------------------------|---|
| |  | SOMW 0803.. (For KPTK) | AHFM-S00803-D20-M10-L30-Z02-H AHFM-S00803-D25-M12-L35-Z03-H AHFM-S00803-D32-M16-L43-Z03-H AHFM-S00803-D32-M16-L43-Z04-H AHFM-S00803-D40-M16-L43-Z04-H |

S Sistem Hızlı İlerlemeli Parmak Frezeler / S System Highfeed End Mills

| ° | AHFM-S00803 | Uç / Insert | Takım Kodu / Tool Code |
|---|--|---------------------------|--|
| |  | SOMW 0803.. (For KPTK) | AHFM-S00803-D20-W20-L150-Z02 AHFM-S00803-D25-W25-L150-Z03 AHFM-S00803-D32-W32-L150-Z04 |

S Sistem Hızlı İlerlemeli Parmak Frezeler / S System Highfeed End Mills

| ° | AHFM-SP1004 | Uç / Insert | Takım Kodu / Tool Code |
|---|---|--------------------------|--|
| |  | SPNW 1004.. (For DJT) | AHFM-SP1004-D25-C25-L150-Z02 AHFM-SP1004-D32-C32-L150-Z03 |

S Sistem Hızlı İlerlemeli Modüler Parmak Frezeler / S System Modular Highfeed End Mills (Screw Type Tools)

| ° | AHFM-SP1004 | Uç / Insert | Takım Kodu / Tool Code |
|---|---|--------------------------|--|
| |  | SPNW 1004.. (For DJT) | AHFM-SP1004-D25-M12-L35-Z02-H AHFM-SP1004-D32-M16-L43-Z03-H AHFM-SP1004-D35-M16-L43-Z03-H AHFM-SP1004-D42-M16-L43-Z04-H |

Hızlı İlerlemeli Frezeler / High Feed Milling Tools

| ° | AHFM-SP1004 | Uç / Insert | Takım Kodu / Tool Code |
|---|---|--------------------------|--|
| |  | SPNW 1004.. (For DJT) | AHFM-SP1004-D050-A22-Z05-H AHFM-SP1004-D052-A22-Z05-H AHFM-SP1004-D063-A22-Z06-H |

S Sistem Hızlı İlerlemeli Parmak Frezeler / S System Highfeed End Mills

| ° | AHFM-WD.. | Uç / Insert | Takım Kodu / Tool Code |
|---|---|--|--|
| |  | WD.T 0503.. (For DJT) WD.W 06T3.. (For DJT) | AHFM-WD0503D-D20-C20-L150-Z02 AHFM-WD0503D-D21-C20-L150-Z02 AHFMC-WD06T3D-D26-C25-L200-Z02 AHFMC-WD06T3D-D33-C32-L200-Z03 |

S Sistem Hızlı İlerlemeli Modüler Parmak Frezeler / S System Modular Highfeed End Mills (Screw Type Tools)

| ° | AHFM-WD.. | Uç / Insert | Takım Kodu / Tool Code |
|---|--|---|--|
| |  | WD.T 0503.. (For DJT) WD.W 06T3.. (For DJT) WD.W 0805.. (For DJT) | AHFM-WD0503D-D20-M10-L30-Z02-H AHFM-WD0503D-D25-M12-L35-Z03-H AHFM-WD0503D-D32-M16-L43-Z04-H AHFM-WD0503D-D40-M16-L43-Z05-H AHFMC-WD06T3D-D35-M16-L43-Z03-H AHFMC-WD0805D-D32-M16-L43-Z02-H |

Hızlı İlerlemeli Frezeler / High Feed Milling Tools

| ° | AHFMC-WD.. | Uç / Insert | Takım Kodu / Tool Code |
|---|--|--|--|
| |  | WD.W 06T3.. (For DJT) WD.W 0805.. (For DJT) WD.W 10X6.. (For DJT) | AHFMC-WD06T3D-D042-A16-Z04-H AHFMC-WD06T3D-D050-A22-Z05-H AHFMC-WD06T3D-D052-A22-Z05-H AHFMC-WD0805D-D052-A22-Z04-H AHFMC-WD0805D-D063-A22-Z05-H AHFMC-WD0805D-D063-A27-Z05-H AHFMC-WD0805D-D066-A27-Z05-H AHFMC-WD0805D-D080-A27-Z05 AHFMC-WD0805D-D100-A32-Z06 AHFMC-WD10X6D-D125-B40-Z06 AHFMC-WD10X6D-D160-C40-Z07 |

S Sistem Hızlı İlerlemeli Modüler Parmak Frezeler / S System Modular Highfeed End Mills (Screw Type Tools)

| ° | AHFM-S01004 | Uç / Insert | Takım Kodu / Tool Code |
|---|--|---------------------------|---|
| |  | SOMT 1004.. (For KYCR) | AHFM-S01004-D32-M16-L40-Z03-H AHFM-S01004-D40-M16-L40-Z04-H AHFM-S01004-D42-M16-L40-Z04-H |

Hızlı İlerlemeli Frezeler / High Feed Milling Tools

| ° | AHFM-S01004 | Uç / Insert | Takım Kodu / Tool Code |
|---|--|---------------------------|--|
| |  | SOMT 1004.. (For KYCR) | AHFM-S01004-D050-A22-Z05-H AHFM-S01004-D063-A22-Z06-H AHFM-S01004-D080-A27-Z07-H |

S Sistem Hızlı İlerlemeli Parmak Frezeler / S System Highfeed End Mills

| ° | AHFMC-WD.. | Uç / Insert | Takım Kodu / Tool Code |
|---|--|---|--|
| |  | WDMT 0603.. (For SMTM) WDMT 0804.. (For SMTM) WDMT 1205 (For SMTM) | AHFM-WD0603D-D16-C16-L150-Z02 AHFM-WD0603D-D20-C20-L150-Z03 AHFMC-WD0804D-D25-C25-L150-Z02 AHFMC-WD0804D-D32-C32-L150-Z03 AHFMC-WD1205D-D32-C32-L150-Z02 |

S Sistem Hızlı İlerlemeli Modüler Parmak Frezeler / S System Modular Highfeed End Mills (Screw Type Tools)

| ° | AHFMC-WD0804 | Uç / Insert | Takım Kodu / Tool Code |
|---|--|---------------------------|--|
| |  | WDMT 0804.. (For SMTM) | AHFMC-WD0804D-D25-M12-L35-Z02-H AHFMC-WD0804D-D32-M16-L35-Z03-H |

Hızlı İlerlemeli Frezeler / High Feed Milling Tools

| ° | AHFMC-WD.. | Uç / Insert | Takım Kodu / Tool Code |
|---|------------|---------------------------|---|
|  | | WDMT 0804.. (For SMTM) | AHFMC-WD0804-D040-A16-Z04-H AHFMC-WD0804-D050-A22-Z04-H |
| | | WDMT 1205.. (For SMTM) | AHFMC-WD1205-D052-A22-Z04-H AHFMC-WD1205-D063-A22-Z05-H AHFMC-WD1205-D080-A27-Z06-H |

S Sistem Hızlı İlerlemeli Parmak Frezeler / S System Highfeed End Mills

| ° | AHFM-W004T2 | Uç / Insert | Takım Kodu / Tool Code |
|--|-------------|--------------------------|--|
|  | | WOMW 04T2.. (For DJT) | AHFM-W004T2D-D16-C16-L150-Z02 AHFM-W004T2D-D17-C16-L150-Z02 |

S Sistem Hızlı İlerlemeli Modüler Parmak Frezeler / S System Modular Highfeed End Mills (Screw Type Tools)

| ° | AHFM-WN09T3 | Uç / Insert | Takım Kodu / Tool Code |
|---|-------------|---------------------------|--|
|  | | WNMX 09T3.. (For KRLY) | AHFM-WN09T3-D32-M16-L40-Z03-H AHFM-WN09T3-D40-M16-L40-Z04-H |

S Sistem Hızlı İlerlemeli Parmak Frezeler / S System Highfeed End Mills

| ° | AHFM-Y00602 | Uç / Insert | Takım Kodu / Tool Code |
|--|-------------|--------------------------|--|
|  | | YOHW 0602.. (For DJT) | AHFM-Y00602-D10-C09-L120-Z02-F AHFM-Y00602-D10-C10-L080-Z02-F AHFM-Y00602-D10-C10-L120-Z02-F AHFM-Y00602-D10-C10-L120-Z02-H-F AHFM-Y00602-D10-C10-L120-Z02-H AHFM-Y00602-D12-C11-L120-Z02-F AHFM-Y00602-D12-C11-L120-Z02-H-F AHFM-Y00602-D12-C11-L120-Z02-H AHFM-Y00602-D12-C11-L120-Z03-F AHFM-Y00602-D12-C12-L080-Z02-F AHFM-Y00602-D12-C12-L080-Z03-F AHFM-Y00602-D12-C12-L120-Z02-F AHFM-Y00602-D12-C12-L120-Z02-H AHFM-Y00602-D12-C12-L120-Z03-F AHFM-Y00602-D12-C12-L120-Z03-H |

S Sistem Hızlı İlerlemeli Parmak Frezeler / S System Highfeed End Mills

| ° | AHFM-WN.. | Uç / Insert | Takım Kodu / Tool Code |
|---|-----------|---------------------------|---|
|  | | WNMX 0603.. (For KRLY) | AHFM-WN0603-D16-C16-L110-Z02-H AHFM-WN0603-D16-C16-L150-Z02-H AHFM-WN0603-D17-C16-L150-Z02-H AHFM-WN0603-D20-C20-L150-Z02-H AHFM-WN0603-D20-C20-L200-Z02-H AHFM-WN0603-D21-C20-L150-Z02-H |
| | | WNMX 09T3.. (For KRLY) | AHFM-WN09T3-D25-W25-L120-Z02-H AHFML-WN09T3-D25-W25-L120-Z02-H AHFM-WN09T3-D25-C25-L200-Z02 AHFM-WN09T3-D32-W32-L120-Z03-H AHFM-WN09T3-D32-W32-L200-Z03-H AHFM-WN09T3-D35-W32-L200-Z04-H AHFM-WN09T3-D40-W32-L120-Z04-H AHFM-WN09T3-D40-C32-L200-Z04 |
| | | WNMX 1305.. (For KRLY) | AHFM-WN1305-D32-C32-L150-Z02-H AHFM-WN1305-D32-C32-L200-Z02-H AHFM-WN1305-D40-C32-L200-Z03-H |

S Sistem Hızlı İlerlemeli Parmak Frezeler / S System Highfeed End Mills

| ° | AHFM-YP1003 | Uç / Insert | Takım Kodu / Tool Code |
|--|-------------|--------------------------|--|
|  | | YPHW 1003.. (For DJT) | AHFM-YP1003-D16-C15-L150-Z02-F AHFM-YP1003-D16-C15-L200-Z02-F AHFM-YP1003-D16-C16-L150-Z02-F AHFM-YP1003-D17-C16-L150-Z02-F AHFM-YP1003-D17-C16-L200-Z02-F AHFM-YP1003-D20-C18-L150-Z03-F AHFM-YP1003-D20-C18-L200-Z03-F AHFM-YP1003-D20-C20-L150-Z03-F AHFM-YP1003-D21-C20-L150-Z03-F AHFM-YP1003-D21-C20-L150-Z03-H AHFM-YP1003-D21-C20-L150-Z04-F AHFM-YP1003-D21-C20-L200-Z03-F AHFM-YP1003-D21-C20-L200-Z03 AHFM-YP1003-D25-C20-L150-Z04-F AHFM-YP1003-D25-C20-L200-Z04-F AHFM-YP1003-D25-C25-L150-Z04-F AHFM-YP1003-D26-C25-L150-Z04-F AHFM-YP1003-D26-C25-L150-Z04 AHFM-YP1003-D26-C25-L200-Z03-F AHFM-YP1003-D26-C25-L200-Z04-F |

Hızlı İlerlemeli Frezeler / High Feed Milling Tools

| ° | AHFM-WN09T3 | Uç / Insert | Takım Kodu / Tool Code |
|---|-------------|---------------------------|--|
|  | | WNMX 09T3.. (For KRLY) | AHFM-WN09T3-D040-A16-Z04-H AHFML-WN09T3-D040-A16-Z04-H AHFM-WN09T3-D050-A22-Z05-H AHFML-WN09T3-D050-A22-Z05-H AHFM-WN09T3-D063-A22-Z06 |

S Sistem Hızlı İlerlemeli Modüler Parmak Frezeler / S System Modular Highfeed End Mills (Screw Type Tools)

| ° | AHFM-YP1003 | Uç / Insert | Takım Kodu / Tool Code |
|--|-------------|--------------------------|--|
|  | | YPHW 1003.. (For DJT) | AHFM-YP1003-D16-M08-L23-Z02-F AHFM-YP1003-D16-M08-L23-Z02-H-F AHFM-YP1003-D17-M08-L23-Z02-H-F AHFM-YP1003-D17-M08-L23-Z02-H AHFM-YP1003-D20-M10-L30-Z03-H-F AHFM-YP1003-D20-M10-L30-Z03-H AHFM-YP1003-D20-M10-L30-Z04-F AHFM-YP1003-D21-M10-L30-Z03-H-F AHFM-YP1003-D21-M10-L30-Z03-H AHFM-YP1003-D25-M12-L35-Z04-H AHFM-YP1003-D25-M12-L35-Z04-H-F AHFM-YP1003-D26-M12-L35-Z04-H-F AHFM-YP1003-D32-M16-L30-Z05-F AHFM-YP1003-D32-M16-L43-Z05-H-F AHFM-YP1003-D40-M16-L43-Z06-H-F AHFM-YP1003-D42-M16-L43-Z06-H-F |

Hızlı İlerlemeli Frezeler / High Feed Milling Tools



| ° | AHFM-WN0907 | Uç / Insert | Takım Kodu / Tool Code |
|---|-------------|--------------------------|--|
|  | | WNMU 0907.. (For DJT) | AHFM-WN0907-D050-A22-Z04-H AHFM-WN0907-D052-A22-Z04-H AHFM-WN0907-D063-A22-Z05-H AHFM-WN0907-D066-A27-Z05-H AHFM-WN0907-D080-A27-Z06-H AHFM-WN0907-D100-A32-Z07-H |

Frezeleme Takımları / Milling Tools



T Kanal Frezeler / T Slot Milling

| 90° | ATSM90-CC.. | Uç / Insert | Takım Kodu / Tool Code |
|---|---------------------------------|----------------------------------|------------------------|
|  | CC.. 0602.. | ATSM90-CC06-D17X8-W16-L85-Z02 | |
| | CC.. 0602.. | ATSM90-CC06-D28X8-W20-L66-Z04 | |
| | CC.. 0602.. | ATSM90-CC06-D32X8-W25-L100-Z04 | |
| | CC.. 0602.. | ATSM90-CC06-D45.5X8-W25-L100-Z06 | |
| | CC.. 0602.. | ATSM90-CC06-D63X8-W32-L125-Z08 | |
| | CC.. 0602.. | ATSM90-CC06-D18X9-W16-L90-Z02 | |
| | CC.. 0602.. | ATSM90-CC06-D20X9-W16-L85-Z04 | |
| | CC.. 0602.. | ATSM90-CC06-D23X10-W20-L90-Z04 | |
| | CC.. 0602.. | ATSM90-CC06-D32X10-W25-L100-Z04 | |
| | CC.. 0602.. | ATSM90-CC06-D45X10-W32-L120-Z06 | |
| | (For ISO) | ATSM90-CC06-D25X11-W25-L100-Z04 | |
| | CC.. 09T3.. | ATSM90-CC09-D30X12-W25-L100-Z04 | |
| | CC.. 09T3.. | ATSM90-CC09-D32X12-W25-L100-Z02 | |
| | CC.. 09T3.. | ATSM90-CC09-D32X12-W25-L100-Z04 | |
| | CC.. 09T3.. | ATSM90-CC09-D32X14-W25-L100-Z04 | |
| | CC.. 09T3.. | ATSM90-CC09-D37X16-W32-L120-Z04 | |
| | (For ISO) | ATSM90-CC09-D42X17-W32-L120-Z04 | |
| | CC.. 1204.. | ATSM90-CC12-D47X20-W32-L120-Z04 | |
| | CC.. 1204.. | ATSM90-CC12-D52X21-W32-L120-Z04 | |
| | (For ISO) | ATSM90-CC12-D50X22-W32-L120-Z04 | |
| (For ISO) | ATSM90-CC12-D55X22-W32-L120-Z04 | | |

Disk Frezeler / Disc Milling

| 90° | ASDM-SPGT | Uç / Insert | Takım Kodu / Tool Code | | |
|--|-----------|---|---|--|---|
|  | | SPGT 0502.. (For ZCC) | ASDM-SPGT05-D80x6-d27-Z10 ASDM-SPGT05-D100x6-d32-Z12 ASDM-SPGT05-D125x6-d40-Z14 ASDM-SPGT05-D160x6-d40-Z18 | | |
| | | SPGT 0602.. (For ZCC) | ASDM-SPGT06-D80x7-d27-Z10 ASDM-SPGT06-D100x7-d32-Z12 ASDM-SPGT06-D125x7-d40-Z14 ASDM-SPGT06-D160x7-d40-Z16 ASDM-SPGT06-D200x7-d40-Z18 | | |
| | | SPGT 0702.. (For ZCC) | ASDM-SPGT07-D100x10-d32-Z12 | | |
| 90° | ASDM-CC.. | Uç / Insert | Takım Kodu / Tool Code | | |
|  | | CC.. 0602.. (For ISO) | ASDM-CC06-D80x8-d27-Z10 ASDM-CC06-D100x8-d32-Z12 ASDM-CC06-D125x8-d40-Z14 ASDM-CC06-D160x8-d40-Z16 ASDM-CC06-D200x8-d40-Z18 ASDM-CC06-D80x10-d27-Z10 | | |
| | | | ASDM-CC06-D100x10-d32-Z12 ASDM-CC06-D125x10-d40-Z14 ASDM-CC06-D160x10-d40-Z16 ASDM-CC06-D200x10-d40-Z18 | | |
| | | | CC.. 09T3.. (For ISO) | ASDM-CC09-D80x12-d27-Z08 ASDM-CC09-D100x12-d32-Z10 ASDM-CC09-D125x12-d40-Z12 ASDM-CC09-D160x12-d40-Z14 ASDM-CC09-D200x12-d40-Z16 ASDM-CC09-D80x14-d27-Z08 | |
| | | | | ASDM-CC09-D100x14-d32-Z10 ASDM-CC09-D125x14-d40-Z12 ASDM-CC09-D160x14-d40-Z14 ASDM-CC09-D200x14-d40-Z16 | |
| | | | | CC.. 1204.. (For ISO) | ASDM-CC12-D80x16-d27-Z06 ASDM-CC12-D100x16-d32-Z08 ASDM-CC12-D125x16-d40-Z10 ASDM-CC12-D160x16-d40-Z12 ASDM-CC12-D200x16-d40-Z14 ASDM-CC12-D80x18-d27-Z06 |
| | | | | | ASDM-CC12-D100x18-d32-Z08 ASDM-CC12-D125x18-d40-Z10 ASDM-CC12-D160x18-d40-Z12 ASDM-CC12-D200x18-d40-Z14 ASDM-CC12-D250x18-d40-Z16 ASDM-CC12-D80x20-d27-Z06 |
| | | ASDM-CC12-D100x20-d32-Z08 ASDM-CC12-D125x20-d40-Z10 ASDM-CC12-D160x20-d40-Z12 ASDM-CC12-D200x20-d40-Z14 ASDM-CC12-D250x20-d40-Z16 | | | |

T Kanal Frezeler / T Slot Milling

| 90° | ATSM90-SP.. | Uç / Insert | Takım Kodu / Tool Code |
|---|---------------------------------------|---------------------------------------|---|
|  | | SPMG 050204 | ATSM90-SP.05-D22.5X5-W25-L100-Z04 |
| | | (For TGTC) | ATSM90-SP.05-D30X5-W25-L100-Z04 |
| | | SPGT 050204 | ATSM90-SPGT0502-D63X6-W32-L125-Z10 |
| | | (For ZCC) | ATSM90-SPGT0904-D32X14-W32-L120-Z04-H |
| | | ATSM90-SPGT0904-D37X16-W32-L120-Z04-H | |
| SPGT 090408 | ATSM90-SPGT0904-D42X17-W32-L120-Z04-H | | |
| (For ZCC) | ATSM90-SPGT1104-D47X20-W32-L120-Z04-H | | |
| SPGT 110408 | ATSM90-SP.06-D80X7-W32-L120-Z10 | | |
| SPMG 060204 | | | |
| (For TGTC) | | | |
| ° | ATSMR-RD.. | Uç / Insert | Takım Kodu / Tool Code |
|  | | RD.. 0702.. (For ISO) | ATSMR-RD0702-D17-W16-L90-Z02 ATSMR-RD0702-D25-W16-L90-Z03 ATSMR-RD0702-D35-W25-L100-Z05 |
| | | RD.. 1003.. (For ISO) | ATSMR-RD1003-D21-W25-L100-Z02 ATSMR-RD1003-D80-W32-L165-Z06-H |
| | | RD.. 12T3.. (For ISO) | ATSMR-RD12T3-D25-W25-L100-Z02 ATSMR-RD12T3-D80-W32-L165-Z06-H |
| | | RD.. 1604.. (For ISO) | ATSMR-RD1604-D34-W32-L110-Z02 |

konusulan
the spoken kalite...
quality...



